

Right Weigh Load Scales

Exterior Digital Load Scale 201-EDG-01(B)



Installation and Operation Manual

Please read carefully before installation



Exterior Digital Load Scale 201-EDG-01(B)



Table of Contents

Specifications & Overview	4
Scale Installation and Electrical Connections	6
Calibration	8
Operating and Weighing Instructions	10
Special Scale Functions	11
Estimated Steer Mode	12
Dual Calibration Mode	14
Security PIN Code	16
Overweight Warning	17
Troubleshooting	18
Appendix A - Additional Parts	20
Appendix B - Wiring Insulation	21
Warranty Statement	22
Return Policy & Repairs	23

The Right Weigh 201-EDG-01(B) digital load scale is a self-contained monitoring device with **one** internal air pressure sensor. This scale will monitor one air suspension single, tandem, or tridem drive axle group or trailer axle group with one height control valve HCV;

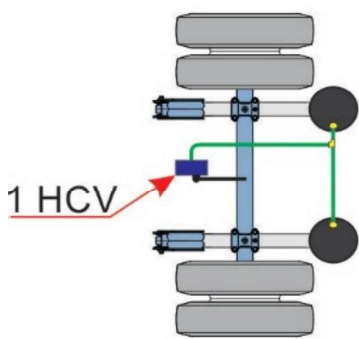

Single Axle Group

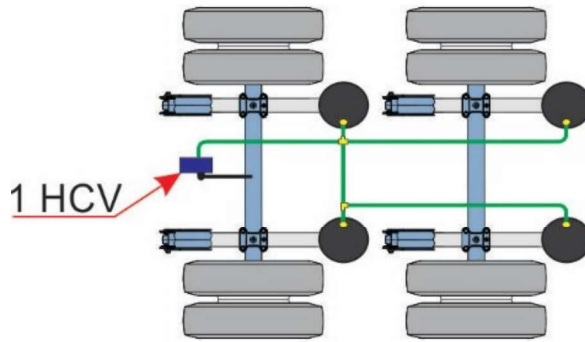

Tandem Axle Group

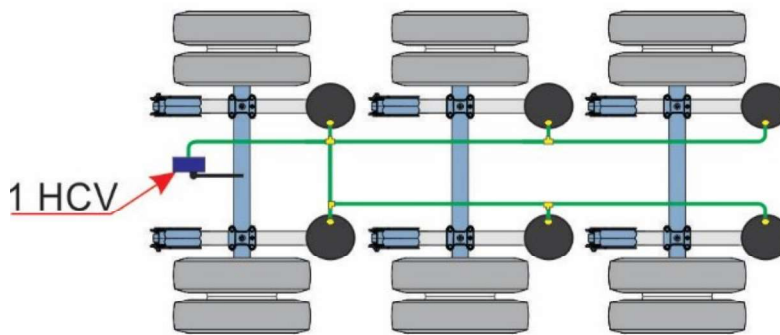

Tri Axle Group



Independent lift axles cannot be considered part of an axle group. The 201-EDG-01(B) digital load scale cannot be used on an axle group that has two HCVs. To monitor an axle group that has two HCVs you will need the 201-EDG-02B digital load scale.

Operating Temperature: -22° F to +185° F (-30° C to +85° C)

Storage Temperature: -40° F to +185° F (-40° C to +85° C)

Power Supply: 9 VDC to 32 VDC

Units: Pounds (LBS) or Kilograms (KG)

Housing: High impact polycarbonate blend

Display: 0.8" LCD sunlight readable

Specifications & Overview

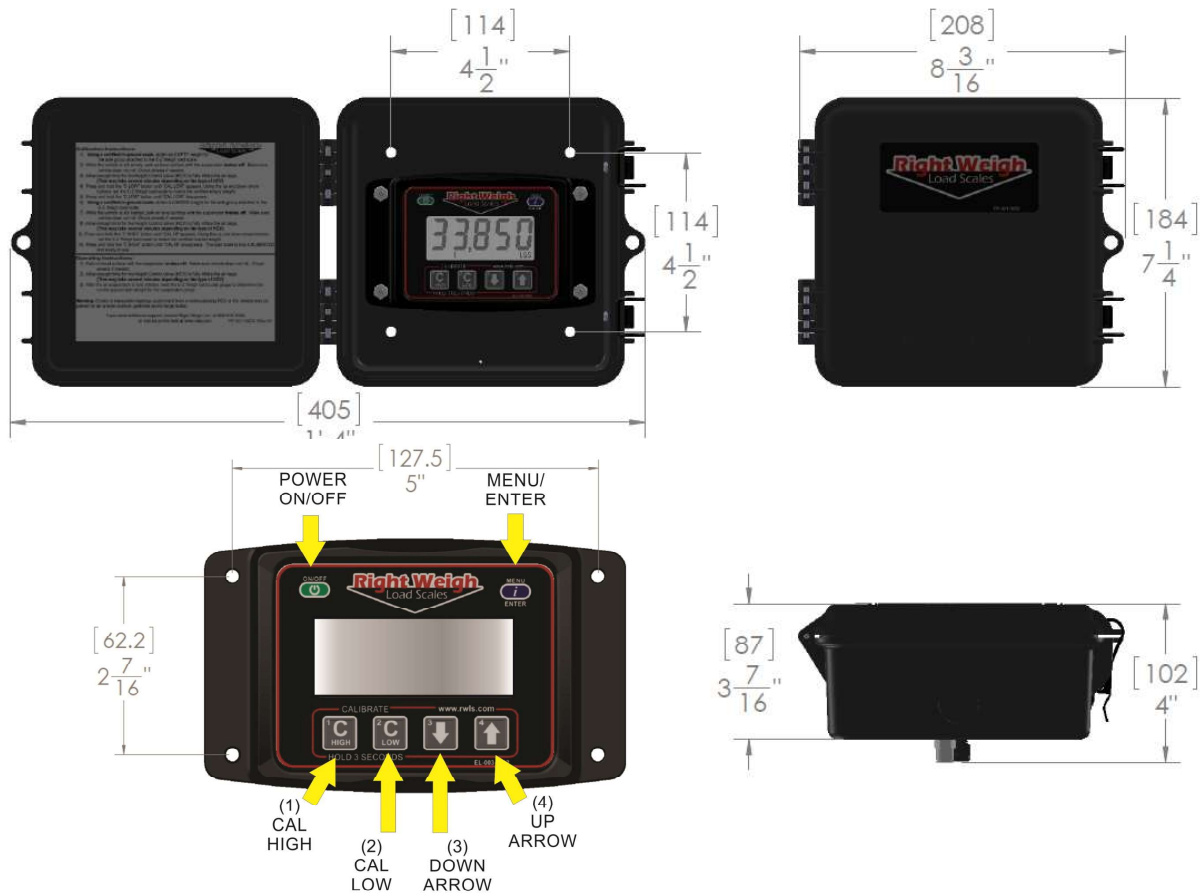

Drop Axle:

This load scale can be used to monitor an axle group with an air ride lift axle if the lift axle air bags are controlled by the same height control valve as the other axles in the group. To do this, the scale will need to be setup using DUAL CALIBRATION mode. For more information please refer to the [Dual Calibration](#) section found under [Special Scale Functions](#).

Steer Axle:

The axle weight of the steers can be estimated if this scale is used to monitor only the drive axle group. For more information, please refer to the [Estimated Steer](#) section found under [Special Scale Functions](#).



The 201-EDG-01(B) load scale cannot be operated in both Dual Calibration and Estimated Steer at the same time. If you choose to operate the scale in DUAL CALIBRATION or ESTIMATED STEER mode, you will need to put the scale into that mode before you perform calibration.

The 201-EDG-01 digital scale is designed to be mounted on the outside of a truck or trailer, however the 201-EDG-01 should still be mounted in a protective enclosure. A protective box and mounting bracket are included with the 201-EDG-01B. Choose a location on the vehicle to mount the scale that is easily accessible and safe from potential damage (posts, forklifts, tire caps, etc.).

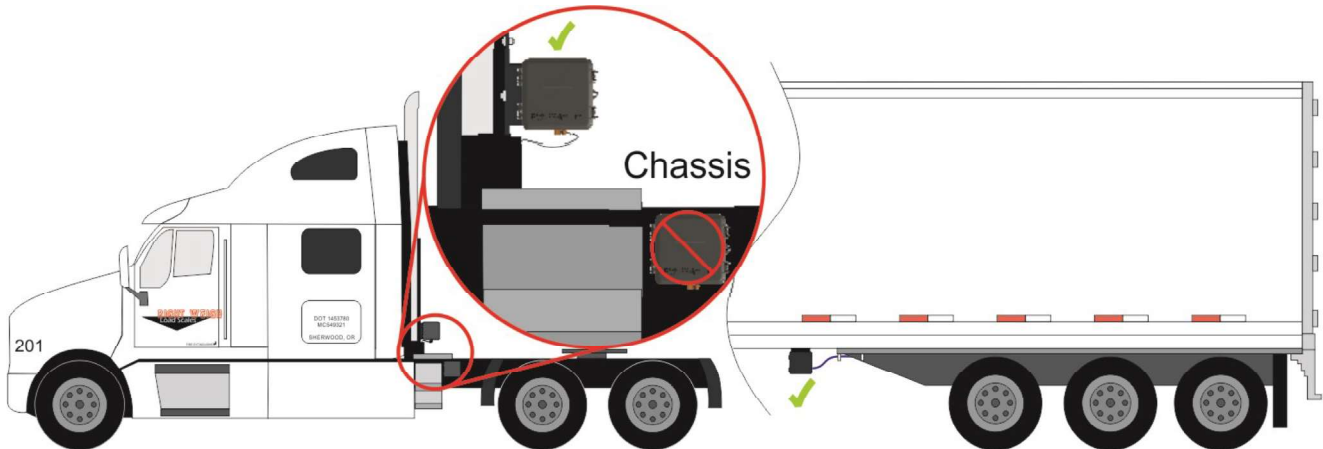

 **DO NOT** mount the scale directly to the chassis or any other main beam unless it is approved by the vehicle manufacturer. Doing so may void the warranty with the vehicle manufacturer.

Step 1: Mount the supplied bracket in the chosen location and install the protective box to the bracket using the supplied hardware.



Step 2: Dump the air from the suspension system. Locate and remove the suspension air line fitting from the top of one of the air bags connected to the height control valve.



Scale Installation and Electrical Connections

Step 3: Insert a street tee fitting into the top of the air bag. The street tee fitting should match the thread size and type of the vehicle suspension. Reinstall the suspension air line and fitting into the street tee. For a list of recommended hardware, please see Appendix A.

Insert suspension air line and fitting into the tee fitting



Step 4: Install a new 1/4" air line and fitting to be used with the Right Weigh load scale into the street tee.

Insert new air line and fitting into the tee fitting



Step 5: Run the new 1/4" air line from the street tee fitting to the mounting location of the Right Weigh load scale. Insert the new air line into the push-to-connect fitting on the back of the load scale. Use zip ties to safely secure the air line to the truck or trailer along the way.

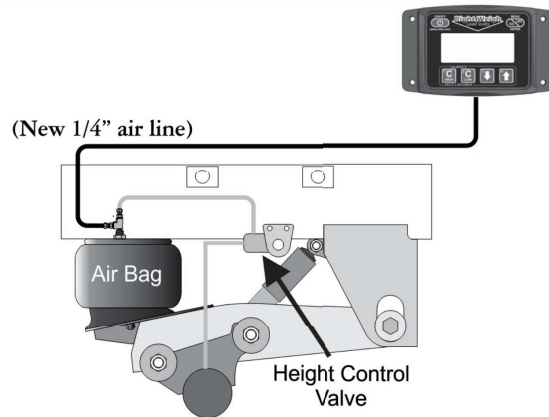

Step 6: Air up the suspension system and check all air fitting connections for leaks.

Step 7: Attach the RED wire on the back of the 201-EDG-01(B) to a positive (+) power source and the BLACK wire to chassis ground (-). The required supply voltage must be between 9 and 32 volts DC.

 Any electrical connections made must be fully insulated from weather to protect the scale and wiring from damage. See Appendix B

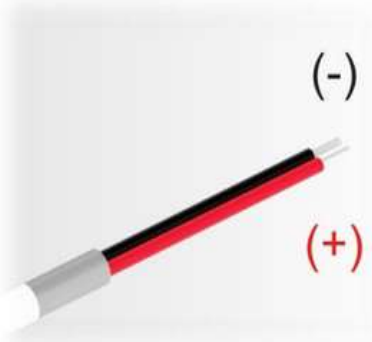

The 201-EDG-01(B) digital load scale uses 2 points of reference (empty and loaded) to accurately calculate axle group weight. To correctly calibrate the Right Weigh load scale, you will need to enter **both** an empty weight and a loaded weight value for the axle group being monitored. It does not matter which value you enter first (empty or loaded), however, when a calibration value is entered the Right Weigh load scale will associate it with the current air pressure in the suspension system at that moment. Therefore, it is required that the empty weight (LOW) value be entered into the Right Weigh load scale when the vehicle is empty, and the loaded weight (HIGH) value be entered when the vehicle is fully loaded.



When entering the loaded weight value, be sure that your vehicle is as close to the maximum legal weight limit as possible.

1. Enter Empty Weight

Step 1: While your vehicle is empty, obtain a weight value for the specific axle group attached to the Right Weigh load scale using a certified ground scale.



Step 2: Park on a level surface. Shift the transmission to neutral and set the parking brakes. If you can stay on the ground scale, that is ideal.

Step 3 : Chock the wheels to prevent unexpected vehicle movement, then release the parking and service brakes.

Step 4: Make sure the height control valve (HCV) has fully inflated the air bags. If needed, briefly dump the air from the suspension and allow the HCV to refill the system. (This may take several minutes depending on the type of HCV.)

Step 5: Press the  button to turn on the Right Weigh load scale.

Step 6: Press and hold the  button for 3 seconds until the words “CAL LO” appear.

Step 7: Using the  and  arrow buttons, adjust the Right Weigh load scale until the weight displayed matches the certified weight from the ground scale.

Step 8: Press and hold the  button again for 3 seconds until the words “CAL LO” disappear.

Calibration



Weigh the entire axle group being monitored. Do not use values such as gross weight, tare weight, or just one axle from a group of 2 or more.

2. Enter Loaded Weight

Step 1: While your vehicle is fully loaded, obtain a weight value for the specific axle group attached to the Right Weigh load scale using a certified ground scale.



Step 2: Park on a level surface. Shift the transmission to neutral and set the parking brakes. If you can stay on the ground scale, that is ideal.

Step 3: Chock the wheels to prevent unexpected vehicle movement, then release the parking and service brakes.

Step 4: Make sure the height control valve (HCV) has fully inflated the air bags. If needed, briefly dump the air from the suspension and allow the HCV to refill the system. (This may take several minutes depending on the type of HCV.)

Step 5: Press the  button to turn on the Right Weigh load scale.

Step 6: Press and hold the  button for 3 seconds until the words “CAL HI” appear.

Step 7: Using the  and  arrow buttons, adjust the Right Weigh load scale until the weight displayed matches the certified weight from the ground scale.

Step 8: Press and hold the  button again for 3 seconds until the words “CAL HI” disappear.

In order for the 201-EDG-01(B) digital load scale to provide the most accurate weight values, you must take care to position the vehicle correctly. For best results, follow these steps:

Step 1: Park on a level surface. Shift the transmission to neutral and set the parking brakes.

Step 2: Chock the wheels to prevent unexpected vehicle movement, then release the parking and service brakes.

Step 3: Make sure the height control valve (HCV) has fully inflated the air bags. If needed, briefly dump the air from the suspension and allow the HCV to refill the system. (This may take several minutes depending on the type of HCV.)

Step 4: Press the  button to turn on the Right Weigh load scale.

Step 5: Adjust the trailer suspension or the load itself until the Right Weigh load scale displays a weight value below your legal limit.

Step 6: Press the  button to turn off the Right Weigh load scale.

 The display will turn itself off after 30 minutes.

 Press the  button to change the display units from LBS to KG.

Special Scale Functions

The next few pages cover some special features that are built into the 201-EDG-01(B) digital load scale.

Estimated Steer Mode:

In this mode, a scale which is monitoring the drive axle group weight will also estimate the steer axle weight. This is based on the fact that the weight ratio between the drive axle group and the steer axle stays very close to the same as weight is applied to the 5th wheel.

Dual Calibration Mode:

In this mode, 2 sets of calibration data can be stored for use when the axle group is weighed under different conditions, such as when an integrated air ride lift axle is in use which uses the same HCV.

Security PIN Code:

A 5 digit PIN code can be set to prevent tampering of the scale calibration information.

Overweight Alert:

As an added visual warning, the LCD display can be set to flash the weight value when a user-defined weight threshold has been exceeded.

When the 201-EDG-01(B) is installed on a tractor to monitor the drive axle group, the scale can be put into a special mode which will estimate the steer axle weight.

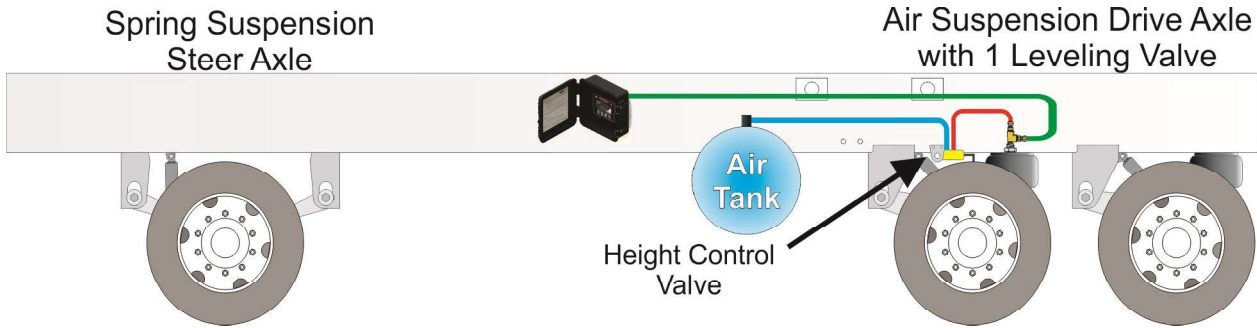

Step 1

Press the  button so that the scale is in the OFF position.

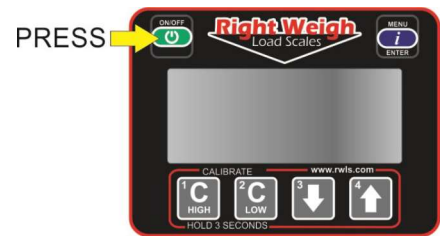



Step 2

While holding the  and  buttons, press the  button.





Step 3

Press the  button to change the configuration from AVERAGE "AVG" to ESTIMATED STEER "ESTr". To confirm the new configuration, turn the scale off by pressing the  button.



Estimated Steer Mode Operation

When the scale is in this mode, operation is slightly different than AVG mode. You will notice that there is now a small number in the lower right of the display, either a 1, 2, or 1 & 2 simultaneously. This is to let you know which axle group is being monitored. The  button is now used to switch between the axle groups. Axle Group 1 mode displays the estimated steer axle weight, Axle Group 2 mode is the drive axle group weight, and 1 & 2 are the two weights combined. To change between LBS and KG press and hold the  button, then press the  button.



Estimated Steer Mode



Estimated Steer Mode Calibration Steps

When calibrating in this mode, you must obtain separate weights for both the drive axle group and steer axle. Refer to the [Calibration](#) section of this manual to familiarize yourself with the normal calibration procedure on page 8.

Enter Both Empty Weights

Step 1: Obtain separate empty weight values for the steer axle and drive axle group from a certified ground scale.



Step 2: Park on a level surface, chock the wheels and release the parking and service brakes. Make sure the HCV has fully inflated the airbags. If necessary, dump the air from the suspension and allow it to refill. Press the  button until the scale is in Axle Group 1 mode. Hold  for 3 seconds until the words “CAL LO” appear.



Step 3: Adjust the value using the  and  arrows so that it matches your scale ticket for the Steer axle. Hold  again for 3 seconds until the words “CAL LO” disappear.

Step 4: Press the  button to change to Axle Group 2 mode, and repeat the process for the drive axle group.

Enter Both Loaded Weights

Step 1: After the truck has been fully loaded, again obtain separate loaded weight values for the steer axle and the drive axle group.

Step 2: Park on a level surface, chock the wheels and release the parking and service brakes. Make sure the HCV has fully inflated the airbags. If necessary, dump the air from the suspension and allow it to refill. Press the  button until the scale is in Axle Group 1 mode. Hold  for 3 seconds until the words “CAL HI” appear.

Step 3: Adjust the value using the  and  arrows so that it matches your scale ticket for the steer axle. Hold  again for 3 seconds until the words “CAL HI” disappear.

Step 4: Press the  button to change to Axle Group 2 mode, and repeat the process for the drive axle group.

The 201-EDG-01(B) digital load scale can be used in a mode which stores 2 sets of calibration data (2CAL). This can be useful for an axle group which has an integrated air ride lift axle using the same HCV, or a suspension which has two operating conditions.

Step 1: Press the button so that the scale is in the OFF position.



Step 2: While holding the and buttons, press the button.



Step 3: Press the button to change the configuration from AVERAGE "AVG" to DUAL CALIBRATION MODE "2CAL". Turn the scale off by pressing the button to confirm your selection.



Dual Calibration Mode Operation

When the scale is in this mode, operation is slightly different than AVG mode.

The button is now used to choose between Configuration 1 and Configuration 2. To change between LBS and KG press and hold the button, then press .

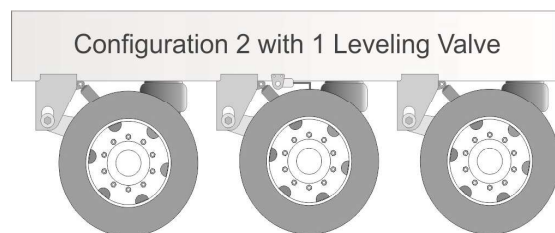
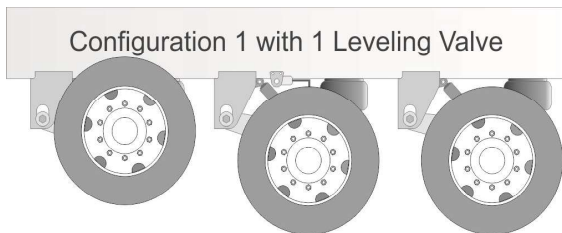

Dual Calibration Mode (2 Cal Mode)



Dual Calibration Mode Calibration Steps

You must calibrate each configuration independently for both loaded and empty values. For example, you may use Configuration 1 for when your lift axle is up, and Configuration 2 for when the lift axle is down. You will need to input both a loaded and empty value for Configuration 1 while the lift axle is up and again a loaded and empty value for Configuration 2 while the lift axle is down.

Enter Both Empty Weights

Step 1: Weigh the axle group being monitored in its first configuration (ex: with the lift axle up) and again in its second configuration (ex: with the lift axle down) using a certified ground scale. It is likely that these values will be very similar, however the air pressure in the system will be much different.

Step 2: Park on a level surface, chock the wheels and release the parking and service brakes. Make sure the HCV has fully inflated the airbags. If necessary, dump the air from the suspension and allow it to refill. With the suspension in its first configuration and the scale in Configuration 1 mode, hold  for 3 seconds until the words "CAL LO" appear.

Step 3: Adjust the value using the  and  arrows so that it matches your scale ticket for the first configuration. Hold  again for 3 seconds until the words "CAL LO" disappear.

Step 4: Put your suspension into its second configuration. Press the  button to change to Configuration 2 mode. Repeat the process for Configuration 2 using the second configuration empty weight.

Enter Both Loaded Weights

Step 1: Repeat Step 1 above to gather weights now that the vehicle is fully loaded.



Step 2: Park on a level surface, chock the wheels and release the parking and service brakes. Make sure the HCV has fully inflated the airbags. If necessary, dump the air from the suspension and allow it to refill. With the suspension in its first configuration and the scale in Configuration 1 mode, hold  for 3 seconds until the words "CAL HI" appear.

Step 3: Adjust the value using the  and  arrows so that it matches your scale ticket for the first configuration. Hold  again for 3 seconds until the words "CAL HI" disappear.



Step 4: Put your suspension into its second configuration. Press the  button to change to Configuration 2 mode. Repeat the process for Configuration 2 using the second configuration loaded weight.

A security PIN code can be added to the 201-EDG-01(B) to prevent tampering with the scale. It will need to be entered to change the calibration values, or to change the PIN code. Keep a copy of the PIN code for future use.

Setting a PIN Code

Step 1: With the scale off, press  while holding  and .



Step 2: Press . The display will show "00000". If the display shows "- - - - -" it means there is already a code set. Enter in a 5 digit PIN code using buttons 1, 2, 3 and 4. Press the  button again to save the PIN.

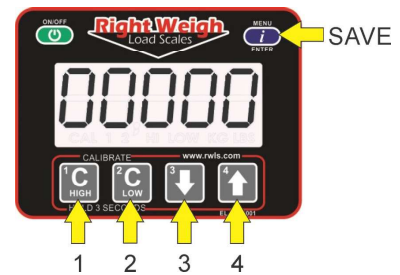

Changing your PIN Code

Step 1: With the scale off, press  while holding  and .



Step 2: Press  the display will show "- - - - -". Enter the previous PIN code. If the correct code was entered, The display will show "Good".

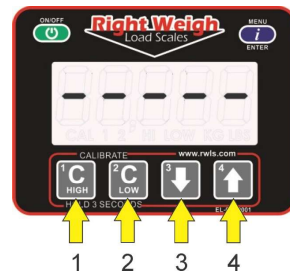

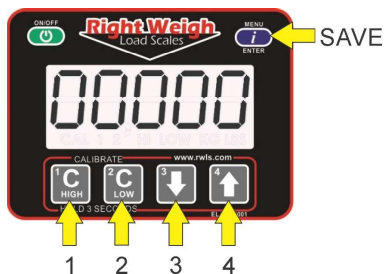

Step 3: Press  and enter the new 5 digit PIN code using buttons 1, 2, 3 and 4. Press  again to save the new PIN.



Overweight Warning

As an added visual warning, the display can be set to flash the weight display on and off when a user is over a predefined weight. For example, you may choose to have the display flash any time the weight on the axle group goes above 33,500 pounds.





Setting an Overweight Warning

Step 1: With the scale turned on, press and hold  and . The word “HI” will appear.



Step 2: The display will show the warning value. “0” is the default setting and the display will not flash the weight at any time if it is set to “0”.



Step 3: Use the  and  arrow buttons to set the desired warning weight. Press and hold  and  to save.



Setting the warning value to “0” will disable the overweight warning feature.

Erratic or inaccurate readings

<p>The vehicle is not parked on a level</p>	<p>Parking on sloped or banked surfaces will cause the vehicle weight distribution to shift between the axle groups.</p>
<p>The vehicle's brakes are on</p>	<p>When the vehicle brakes are set, they could apply additional pressure or torque on the suspension air bags. This will cause the suspension to have a different air pressure than what is actually needed to hold up the</p>
<p>The vehicle is parked on an uneven or rough surface</p>	<p>If one or more of the vehicle's wheels are in a pothole, that could result in additional pressure or torque on the suspension air bags. This will cause the suspension to have a different air pressure than what is actually needed to hold up the given weight.</p>
<p>The height control valve (HCV) is malfunctioning or broken</p>	<p>If the HCV is not functioning correctly, the air pressure applied to the suspension system could be inconsistent and/or erratic. To test for an HCV problem, acquire a weight reading from the Right Weigh load scale and write it down (refer to scale operating instructions for proper procedure). Drive the vehicle around the block and return to the same location. Acquire a second reading from the Right Weigh load scale. If the two readings are significantly different, then the HCV might be malfunctioning.</p>
<p>There is a significant air leak in the suspension system</p>	<p>This could cause the HCV to refill the suspension at regular intervals to maintain the vehicles ride height. If there is a significant leak, the scale display will slowly decrease in value and then quickly increase in value when the HCV refills the suspension system.</p>

Troubleshooting

Scale does not power on:

Scale is not connected to a power source of between 9 and 32 volts	If there is a bad connection in the circuit which causes voltage to drop below 9 volts, the scale will not power on. Test the power source with a voltmeter.
Polarity is incorrect	The red wire must be connected to positive, and the black to negative.

Scale Display is Blinking

Current weight is above the alarm limit programed by the user	With scale on, press and hold the 1 & 2 buttons simultaneously. The display will show the alarm limit weight. To remove the alarm weight, set this number to 0 using the down arrow, and then hold 1 & 2 again until the display is cleared.
---	--

Cannot Change Calibration Data

The scale has an active user-defined security PIN.	If the scale is protected with a passcode, the PIN number must be entered before calibration data can be changed. The scale will display "CodE" and the previously set 5 digit PIN number must be entered to change the data.
--	---

Scale will not Calibrate Low

Air Pressure in system is not changing	<p>To enter CAL LOW mode, the 201-EDG-01(B) load scale must see a measurable change in air pressure from when you calibrated high.</p> <ul style="list-style-type: none">• Make sure you calibrate high while your trailer is near the legal limit, and cal low when the trailer is empty.• Be sure the air line is connected to an air bag and not connected to the main air supply or air brake system.
--	--

The following is a list of additional parts needed for air line installation. This list is just a suggestion and may not be all of the parts needed for your specific vehicle. Check with your Right Weigh dealer for optional installation kits.

- Approximately 20 to 30 feet (6 to 9 meters) or more of 1/4" rigid air line.
- Street tee fitting. The thread size should match the air bag fitting. (1/4" NPT or 3/8" NPT)
- Male straight air line fitting for 1/4" air line, with a thread size to match the street tee fitting.
- 20 or more zip ties.

1/4 Inch Air Line



Street Tee Fitting

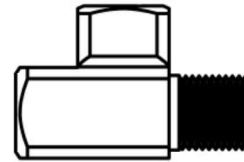

Male Straight Fitting

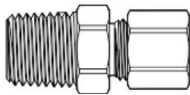

20 or More Zip-Ties



Appendix B - Wiring Insulation

It is very important that all wiring connections be made watertight. Connections which are not watertight will allow moisture to travel through the individual strands of the wires and make it's way into the scale, causing permanent damage to the electronics.

Heat shrinkable splices are included with the 201-SK installation kit.

Crimp each end of the wire into the connector with a wire crimp tool (tool not provided).

With a heat gun or heat torch, heat the connector until it shrinks completely around each wire end. Make sure you do not burn the wire jacket.



After all connections have been made, completely wrap the cable connections with electrical tape, heat shrink tubing, or other environmental protections.

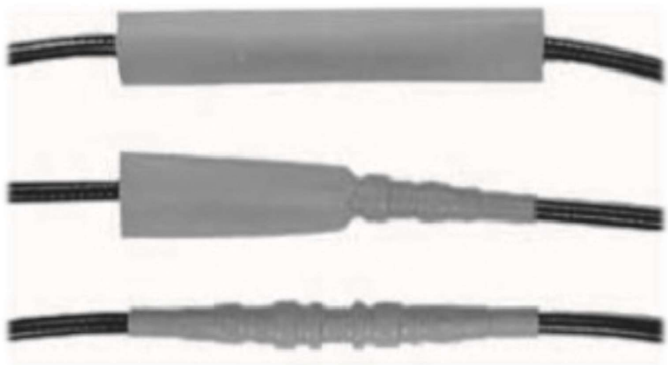

Warranty Statement

Right Weigh is committed to providing quality products that function as intended, and we always stand behind our workmanship. Our industry-leading warranty is our best effort to express this commitment. Products manufactured or sold by Right Weigh, Inc. are warranted to be free from significant defects in material and workmanship 3 years from date of purchase. During this time, and within the boundaries set forth in this warranty statement, Right Weigh, Inc. will, at its sole discretion, correct the product problem or replace the product.

This warranty shall not apply to product problems resulting from: (1) Improper application, installation, incorrect wiring, or operation outside of the approved specifications of the product. (2) Accidents, faulty suspension parts or power surges (3) Inadequate maintenance or preparation by the buyer or user (4) Abuse, misuse, or unauthorized modification. (5) Acts of God, lightning strike, floods, fire, earthquake, etc.

Right Weigh, Inc. assumes no responsibility or liability for any loss or damages resulting from use of Right Weigh, Inc. products.

In no event shall Right Weigh, Inc. be liable for direct, indirect, special, incidental or consequential damages (including loss of profits or loss of time) resulting from the performance of a Right Weigh, Inc. product. In all cases, Right Weigh, Inc. liability will be limited to the original cost of the product in question. Right Weigh, Inc. reserves the right to make improvements in design, construction, and appearance of products without notice. Right Weigh, Inc. may at its sole discretion discontinue support, warranty, or repair of products which it deems are obsolete or for which repair parts are no longer available. No employee or agent of Right Weigh, Inc. has the authority to modify the terms of this warranty in any manner whatsoever without the express written permission of Right Weigh, Inc.

Return Policy & Repairs

Return Policy and Authorization

Before returning any product, please obtain a Return Merchandise Authorization number (RMA#) by calling Customer Service at 888-818-2058 or e-mailing rwls@rwls.com. Include the RMA# and information regarding the reason for the return with the returned product. Shipping costs for returns must be prepaid by the customer. For your protection, items must be carefully packed to prevent damage in shipment and insured against possible damage or loss. Right Weigh, Inc. will not be responsible for damage resulting from careless or insufficient packing or loss in transit.

An RMA# must be obtained by the original purchaser before any product can be returned. Only new, unused products may be returned. Installed, used, damaged, modified or customized products can not be returned for credit. Credit will be issued to the original purchaser after evaluation by Right Weigh, Inc.

Repairs/Replacements

An RMA# must be obtained before any product can be returned. Right Weigh, Inc. will evaluate returned products at no charge. If Right Weigh, Inc. determines that the returned product is under warranty it will repair the product or parts thereof at no charge, or if unrepairable, replace it with the same or functionally equivalent product whenever possible. Right Weigh, Inc. will return the product at its expense via a shipping method (carrier to be at sole discretion of Right Weigh, Inc.) equal to or faster than the method used by the customer. Products or parts thereof not covered by warranty will be repaired or replaced at customer expense upon authorization by the customer. Right Weigh, Inc. will return the repaired product at customer expense via a shipping method (carrier to be at sole discretion of Right Weigh, Inc.) equal to or faster than the method used by the customer.

For additional support contact:

United States, Canada and All Other Countries:

Right Weigh, Inc.
Tel: (888) 818-2058
www.rwls.com
rwls@rwls.com

Australia and New Zealand:

Smart Truck Solutions
Tel: 0418 622840



PP-003-0001 Rev E

December 2015

Right Weigh, Inc.

Hillsboro, Oregon, USA

www.rwls.com

©2015 Right Weigh, Inc. All rights reserved.