

Right Weigh Load Scales

 **Bluetooth®** Wireless Technology Enabled
Exterior Digital Load Scale

201-EBT-01(B)

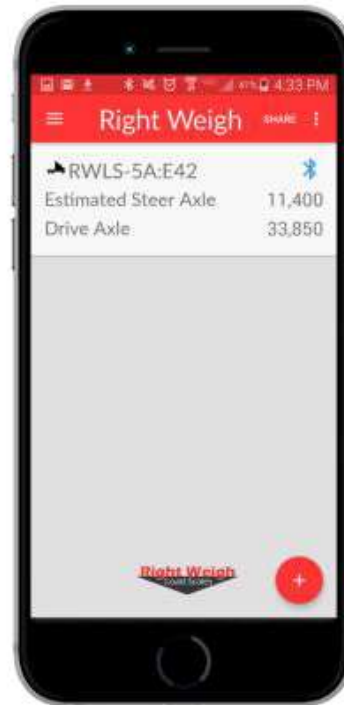

Installation and Operation Manual

Please read carefully before installation

The **Bluetooth**[®] word mark and logos are registered trademarks owned by Bluetooth SIG, Inc. and any use of such marks by Right Weigh, Inc. is under license. Other trademarks and trade names are those of their respective owners.



Bluetooth® Wireless Technology Enabled

Exterior Digital Load Scale

201-EBT-01(B)

Table of Contents

Specifications & Overview	4
Scale Installation and Electrical Connections	6
Calibration	8
Operating and Weighing Instructions	10
Scale Operating Modes	11
Estimated Steer Mode	12
Multiple Calibration Mode	14
Security PIN Code	15
Overweight Warning	16
Right Weigh Bluetooth™ App Overview	17
Unique Scale Identifier	18
Syncing your Device	19
Set the Load Scale Name	23
Settings & Sharing	24
Troubleshooting	25
Appendix A - Additional Parts	27
Appendix B - Wiring Insulation	28
Warranty Statement	29
Return Policy & Repairs	30

The Right Weigh 201-EBT-01(B) digital load scale is a self-contained monitoring device with **one** internal air pressure sensor. This scale will monitor one air suspension single, tandem, or tridem drive axle group or trailer axle group with one height control valve (HCV).

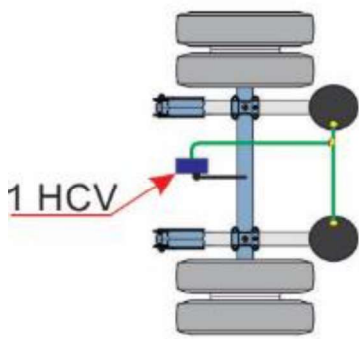

Single Axle Group

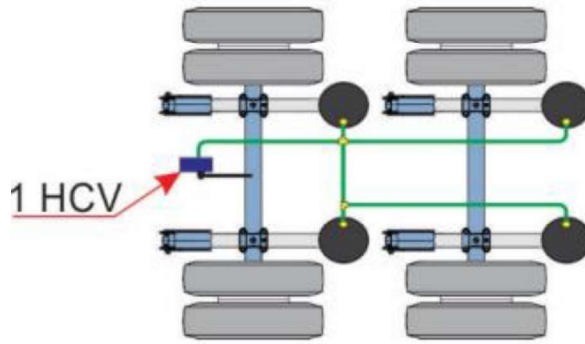

Tandem Axle Group

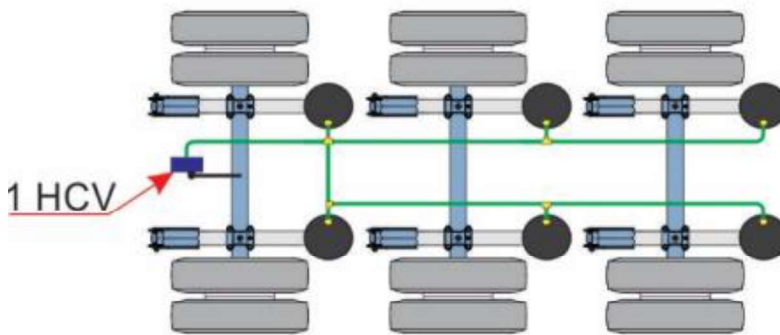

Tri Axle Group



Independent regulated lift axles cannot be considered part of an axle group. The 201-EBT-01(B) digital load scale cannot be used on an axle group that has two HCVs. To monitor an axle group that has two HCVs you will need the 201-EBT-02(B) digital load scale.

Operating Temperature: -22° F to +185° F (-30° C to +85° C)

Storage Temperature: -40° F to +185° F (-40° C to +85° C)

Power Supply: 9 VDC to 32 VDC (Switched)

Units: Pounds (LBS) or Kilograms (KG)

Housing: High impact polycarbonate blend

Display: 0.8" LCD sunlight readable

Specifications & Overview

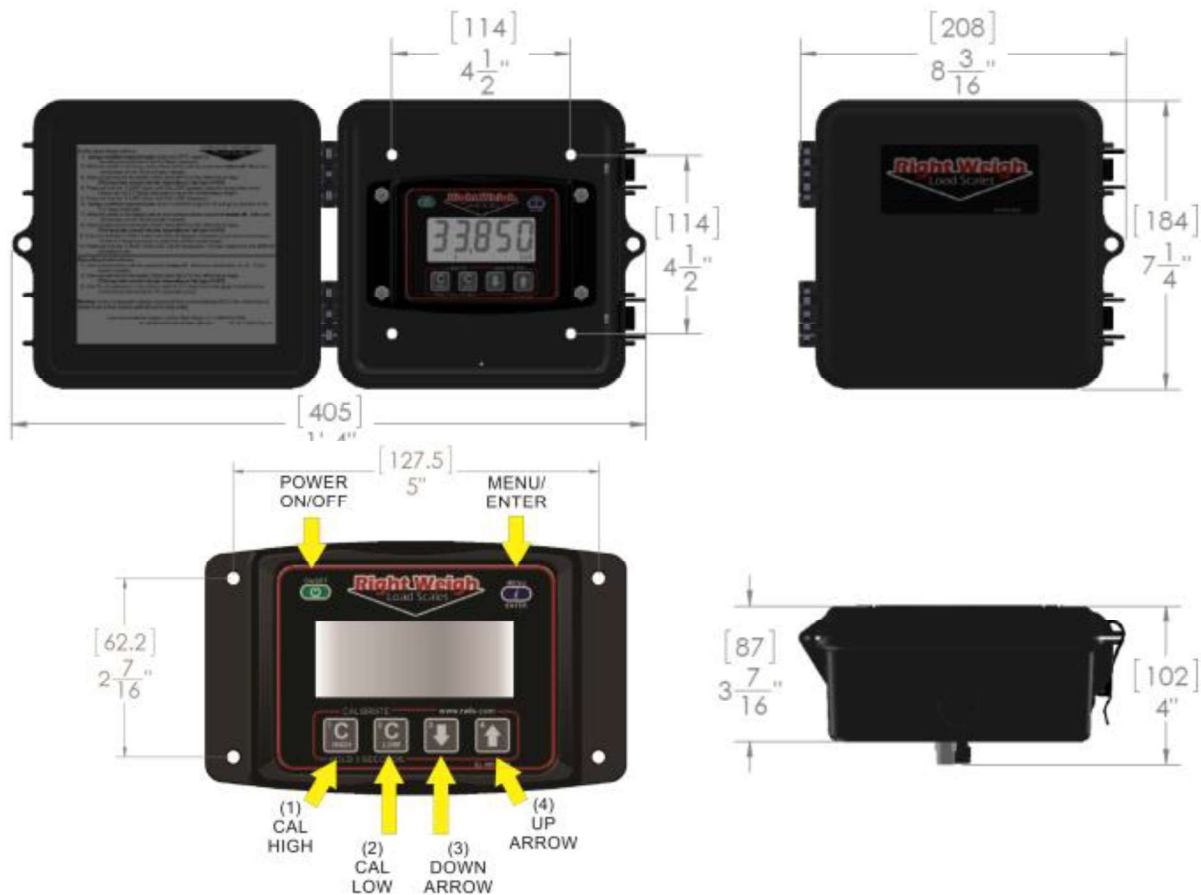

Drop Axle:

This load scale can be used to monitor an axle group with an air ride lift axle if the lift axle air bags are controlled by the same height control valve as the other axles in the group. To do this, the scale will need to be setup using Multiple Calibration mode. For more information please refer to the Multiple Calibration Mode section found under Scale Operating Modes.

Steer Axle:

The weight on the steers can be estimated if this scale is used to monitor the drive axle group. For more information, please refer to the Estimated Steer Mode section found under Scale Operating Modes.



The 201-EBT-01(B) load scale cannot be operated in both Dual Calibration and Estimated Steer mode at the same time. If you choose to operate the scale in Dual Calibration or Estimated Steer mode, you will need to put the scale into that mode before you perform calibration.

The 201-EBT-01 scale is designed to be mounted on the outside of a truck or trailer, however it should still be mounted in a protective enclosure. A protective box and mounting bracket are included with the 201-EBT-01B. Choose a location on the vehicle to mount the scale that is easily accessible and safe from potential damage (Forklift posts, tire caps, etc.).

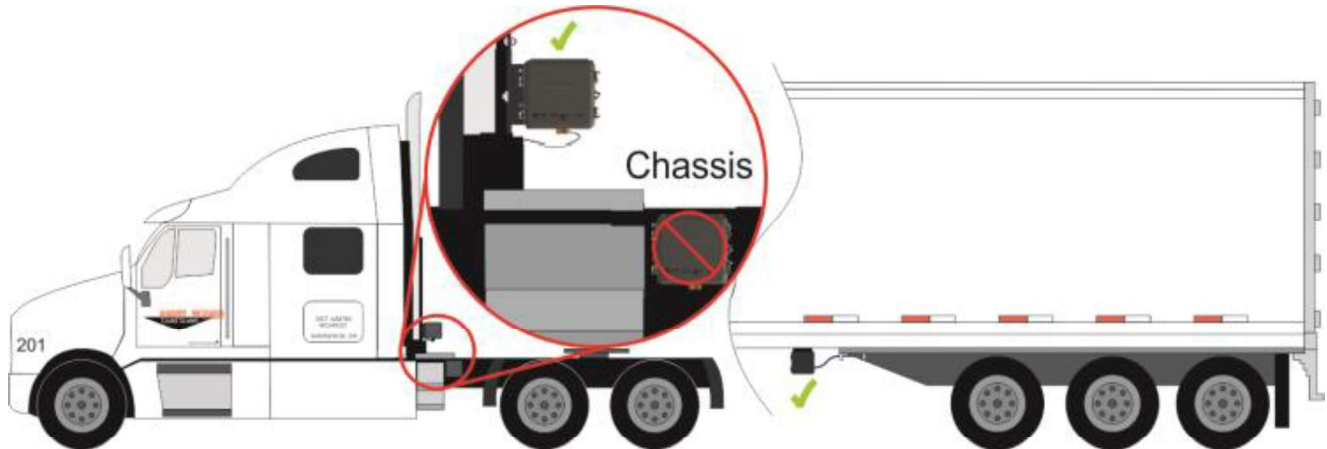

DO NOT mount the scale directly to the chassis or any other main beam unless it is approved by the vehicle manufacturer. Doing so may void the warranty with the vehicle manufacturer.

Step 1: Mount the supplied bracket in the chosen location and install the protective box to the bracket using the supplied hardware.



Step 2: Dump the air from the suspension system. Locate and remove the suspension air line fitting from the top of one of the air bags connected to the height control valve.



Scale Installation and Electrical Connections

Step 3: Insert a street tee fitting into the top of the air bag. The street tee fitting should match the thread size and type of the vehicle suspension. Reinstall the suspension air line and fitting into the street tee. For a list of recommended hardware, please see Appendix A.

Insert suspension air line and fitting into the tee fitting



Step 4: Install a new 1/4" air line and fitting to be used with the Right Weigh load scale into the street tee.

Insert new air line and fitting into the tee fitting



Step 5: Run the new 1/4" air line from the street tee fitting to the mounting location of the Right Weigh load scale. Insert the new air line into the push-to-connect fitting on the back of the load scale. Use zip ties to safely secure the air line to the truck or trailer along the way.

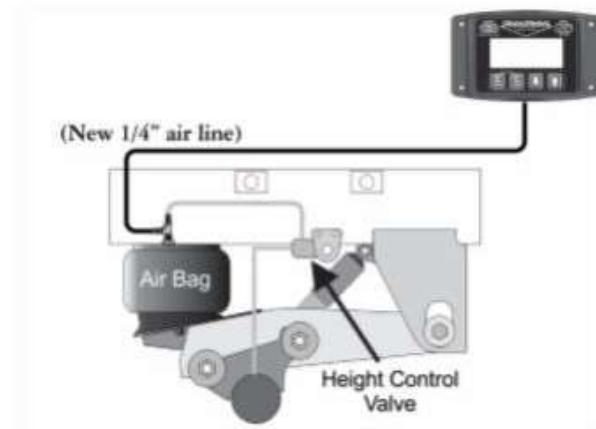

Step 6: Air up the suspension system and check all air fitting connections for leaks.

Step 7: Attach the RED wire on the back of the gauge to a **SWITCHED** positive (+) power source and the BLACK wire to chassis ground (-). The required supply voltage must be between 9 and 32 volts DC. Do not connect to constant battery power.



Any electrical connections made must be fully insulated from weather to protect the scale and wiring from damage. See Appendix B

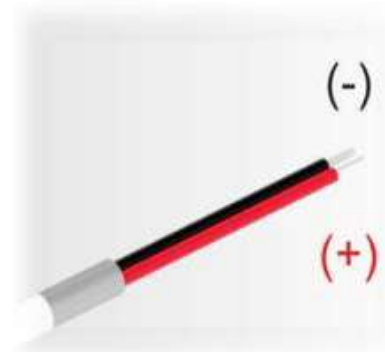

The 201-EBT-01(B) load scale must be calibrated both empty and loaded to work properly. The scale associates the air pressure in the suspension system to the weight you enter at the time of calibration. You will need to calibrate once while the vehicle is empty, and again while the vehicle is loaded for each axle group being monitored.



When entering the loaded weight value, be sure that your vehicle is as close to the maximum legal weight limit as possible.

1. Enter Empty Weight

Step 1: While your vehicle is empty, obtain a weight value for the specific axle group attached to the Right Weigh load scale using a certified ground scale.



Step 2: Park on a level surface. Shift the transmission to neutral and set the parking brakes. If you can stay on the ground scale, that is ideal.

Step 3 : Chock the wheels to prevent unexpected vehicle movement, then release the parking and service brakes.

Step 4: Make sure the height control valve (HCV) has fully inflated the air bags. If needed, briefly dump the air from the suspension and allow the HCV to refill the system. (This may take several minutes depending on the type of HCV.)

Step 5: Press the  button to turn on the Right Weigh load scale.

Step 6: Press and hold the  button for 3 seconds until “C/L” appears.

Step 7: Using the  and  arrow buttons, adjust the Right Weigh load scale until the weight displayed matches the certified weight from the ground scale.

Step 8: Press and hold the  button again for 3 seconds until “C/L” disappears.

Calibration



Weigh the entire axle group being monitored. Do not use values such as gross weight, tare weight, or just one axle from a group of 2 or more.

2. Enter Loaded Weight

Step 1: While your vehicle is fully loaded, obtain a weight value for the specific axle group attached to the Right Weigh load scale using a certified ground scale.



Step 2: Park on a level surface. Shift the transmission to neutral and set the parking brakes. If you can stay on the ground scale, that is ideal.

Step 3: Chock the wheels to prevent unexpected vehicle movement, then release the parking and service brakes.

Step 4: Make sure the height control valve (HCV) has fully inflated the air bags. If needed, briefly dump the air from the suspension and allow the HCV to refill the system. (This may take several minutes depending on the type of HCV.)

Step 5: Press the  button to turn on the Right Weigh load scale.

Step 6: Press and hold the  button for 3 seconds until “C/H” appears.

Step 7: Using the  and  arrow buttons, adjust the Right Weigh load scale until the weight displayed matches the certified weight from the ground scale.

Step 8: Press and hold the  button again for 3 seconds until “C/H” disappears

In order for the gauge to provide the most accurate weight values, you must take care to position the vehicle correctly. For best results, follow these steps:

Step 1: Park on a level surface. Shift the transmission to neutral and set the parking brakes.

Step 2: Chock the wheels to prevent unexpected vehicle movement, then release the parking and service brakes.

Step 3: Make sure the height control valve (HCV) has fully inflated the air bags. If needed, briefly dump the air from the suspension and allow the HCV to refill the system. (This may take several minutes depending on the type of HCV)

Step 4: Press the  button to turn on the Right Weigh load scale.

Step 5: Adjust the suspension or the load itself until the Right Weigh load scale displays a weight value below your legal limit.

Step 6: Press the  button to turn off the Right Weigh load scale.



The display will turn itself off after 60 minutes.



To change the units from pounds to kilograms, hold , and press



Scale Operating Modes

The next few pages cover the operation modes that are built into the 201-EBT-01(B). The load scale can only be setup in one operating mode at a time. If the mode is changed, the calibration data will be reset to factory defaults, requiring re-calibration.

Average Mode (AVG): This is the default mode of the scale.

Estimated Steer Mode Average (S-AVG): For monitoring a drive axle group weight and also calculating an estimated steer axle weight based on the weight ratio between the drive axle group and the steer axle.

Multiple Calibration Mode (4CAL): Four sets of calibration data can be stored for use when the axle group is weighed under different conditions, such as when an integrated air ride lift axle is used on the same HCV.

Changing Scale Mode:

1: With the scale **OFF**, hold the ⁴↑ and ³↓ buttons, and press the  button. The scale will display the current mode.

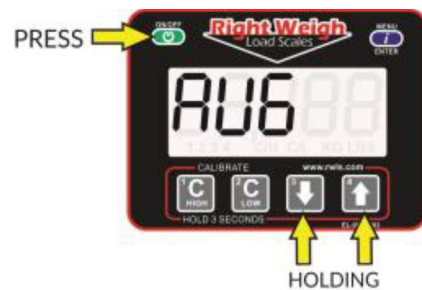

2: Press the ⁴↑ button to cycle through the configuration modes. To confirm your selection, turn the scale off by pressing the  button.



When the 201-EBT-01(B) is installed on a tractor to monitor the drive axle group, the scale can be put into a special mode which will estimate the steer axle weight.

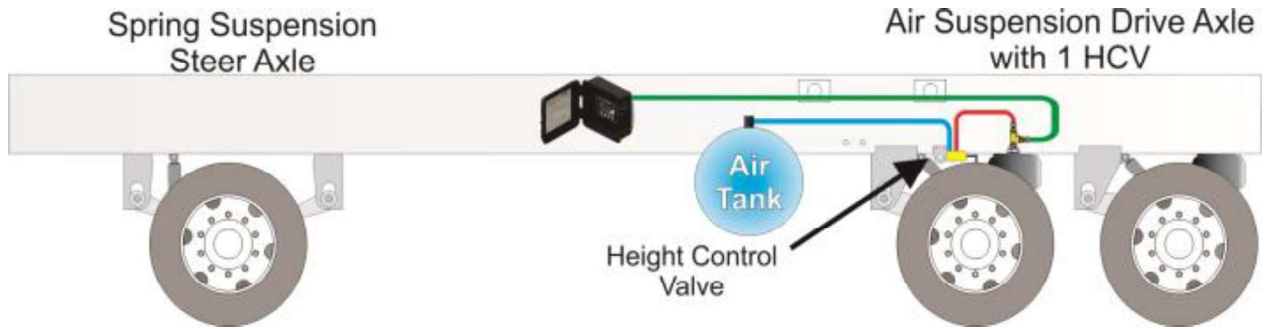

Step 1: With the gauge **OFF**, hold the and buttons, then press the button.



Step 2: Press the button to change the configuration from Average "AVG" to Estimated Steer Average "S-AVG". To save the new configuration, turn the scale off by pressing .



Estimated Steer Mode Operation

There is now a small number in the lower right of the display, either a 1, 2, or 1 & 2 simultaneously. This is to let you know which axle group is being monitored. Use to switch between the axle groups. Axle group 1 mode displays the estimated steer axle weight, axle group 2 mode is the drive axle group weight, and 1 & 2 are the two weights combined.



Estimated Steer Mode



Estimated Steer Mode Calibration

When calibrating in this mode, you must obtain separate weights for both the drive axle group and steer axle. Refer to the calibration section (page 8) in this manual to familiarize yourself with the normal calibration procedure.

Enter Both Empty Weights

Step 1: Obtain separate empty weight values for the steer axle and drive axle group from a certified ground scale.



Step 2: Park on a level surface, chock the wheels and release the parking and service brakes. Make sure the HCV has fully inflated the airbags. If necessary, dump the air from the suspension and allow it to refill. Press the  button until the scale is in axle group 1 mode. Hold  for 3 seconds until “C/L” appears.

Step 3: Adjust the value using the  and  arrows so that it matches your scale ticket for the steer axle. Hold  again for 3 seconds until “C/L” disappears.

Step 4: Press the  button to change to axle group 2 mode, and repeat the process for the drive axle group.

Enter Both Loaded Weights

Step 1: After the truck has been fully loaded, again obtain separate loaded weight values for the steer axle and the drive axle group.

Step 2: Park on a level surface, chock the wheels and release the parking and service brakes. Make sure the HCV has fully inflated the air bags. If necessary, dump the air from the suspension and allow it to refill. Press the  button until the scale is in axle group 1 mode. Hold  for 3 seconds until “C/H” appears.

Step 3: Adjust the value using the  and  arrows so that it matches your scale ticket for the steer axle. Hold  again for 3 seconds until “C/H” disappears.

Step 4: Press the  button to change to Axle Group 2 mode, and repeat the process for the drive axle group.

The 201-EBT-01(B) digital load scale can be used in a mode which stores 4 sets of calibration data. This can be useful for an axle group which has an integrated air ride lift axle using the same HCV, or a suspension which has many operating conditions. Follow these steps to setup in this mode.

Step 1: With the gauge OFF, hold the ⁴↑ and ³↓ buttons, then press the button.



Step 2: Press the ⁴↑ button until "4CAL" is displayed. To save the new configuration, turn the scale off by pressing .



Calibration

The calibration process is the same as Average mode, however, you now have the ability to change between the 4 calibration modes using the button. When calibrating, make sure to calibrate both empty and loaded for each calibration set that you plan on using.

Operation

Use the button to switch between the saved calibrations. A number will appear in the lower left letting you know which calibration set is active.

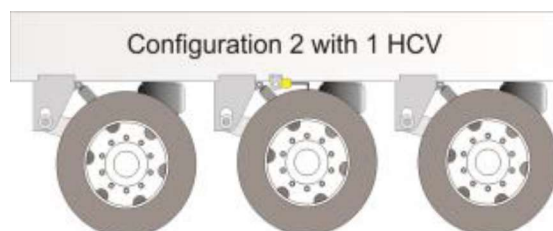
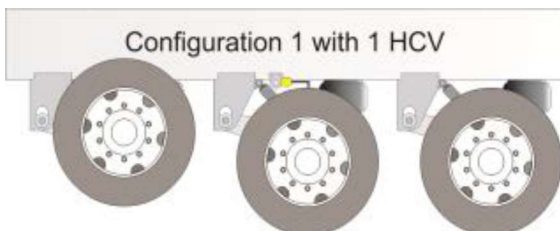



Security PIN Code

A security PIN code can be added to the 201-EBT-01(B) to prevent tampering with the scale. It will need to be entered to change the calibration values, or to change the PIN code. Keep a copy of the PIN code for future use. Once a PIN has been set, it can be changed, but it cannot be removed.

Setting a PIN Code

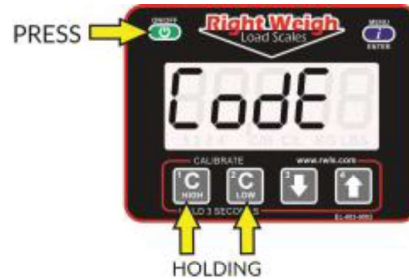
Step 1: With the scale off, press  while holding  and .





Step 2: Press  The display will show "00000". If the display shows "- - - - -" it means there is already a code set. Enter in a 5 digit PIN code using buttons 1, 2, 3 and 4. Press the  button again to save the PIN.



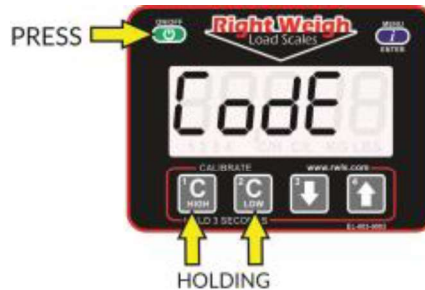

Changing your PIN Code

Step 1: With the scale off, press  while holding  and .



Step 2: Press  the display will show "- - - - -". Enter the previous PIN code. If the correct code was entered, The display will show "Good".



Step 3: Press  and enter the new 5 digit PIN code using buttons 1, 2, 3, and 4. Press  again to save the new PIN.



As an added visual warning, the display can be set to flash when above a set weight. For example, you may choose to have the display flash any time the weight on the axle group goes above 33,500 pounds.

Setting an Overweight Warning

Step 1: With the scale turned on, press and hold and . The C/H symbol will appear.



Step 2: The display will show the warning value. "0" is the default setting and the display will not flash the weight at any time if it is set to "0".



Step 3: Use the and arrow buttons to set the desired warning weight. Press and hold and to save.



Setting the warning value to "0" will disable the overweight warning feature.

Right Weigh Load Scales App Overview

When connected with **Bluetooth**[®] wireless technology enabled Right Weigh load scales, axle group weight readings are displayed on the *Right Weigh Load Scale App*.

The basic steps to connect your Right Weigh load scale to your smart device are:

- Discover the unique name of your load scale(s)
- Setup your load scales to the desired configuration
- Sync your load scale(s) with your smart device

1. Menu, Settings and Support: Use this button to view stored weight data, change the unit of measure (LBS or KG), set warning weight and overload weights, change or add weight data settings and to toggle the option to show the support page on app startup.

2. Scale Name (Truck): The name of the connected truck-mounted scale appears here. Tap the name to set a new name for the scale. The name you set will be saved to the scale itself and the scale will be identified by that name in the future when visible to a device.

3. Scale Name (Trailer): Names of connected trailer-mounted scales appear here. Tap the name to set a new name for the scale. The name you set will be saved to the scale itself and the scale will be identified by that name in the future when visible to a device.

4. Axle Group Name: This name represents the axle group which the scale is monitoring and reflects the operating mode of the scale.

5. Share: This button will open the share data view to send weight data via email.

6. Total Weight: Shows vehicle's total weight

7. Signal Status: A blue icon represents that the device is connected to the scale and is receiving data. A grayed-out icon means the scale has been disconnected. Pressing the refresh button will attempt to reconnect the device to the scale.

8. Add a Scale: Press the "+ Truck" button to add a truck mounted scale to the app. Press the "+ Trailer" button to add a trailer mounted scale to the app.

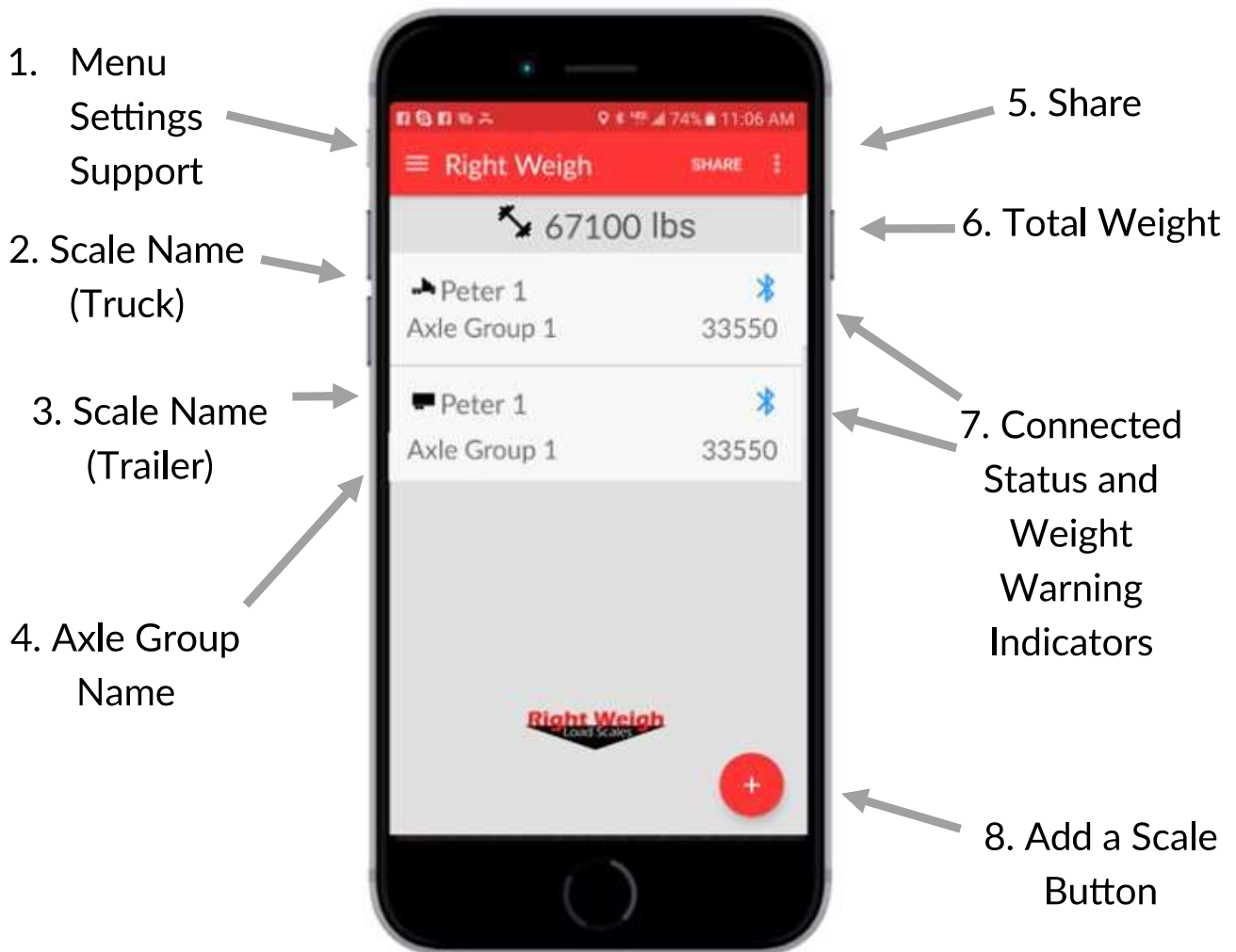

App Home Screen



Unique Scale Identifier

Unique Scale Identifier:

If this is the first time you have used the Right Weigh load scale, you will need to enter a special mode to view the scale's unique identifier. This will help identify the scale when syncing more than one scale with your smart device.

Step 1: With the scale display off hold down the  button, then press the  button.

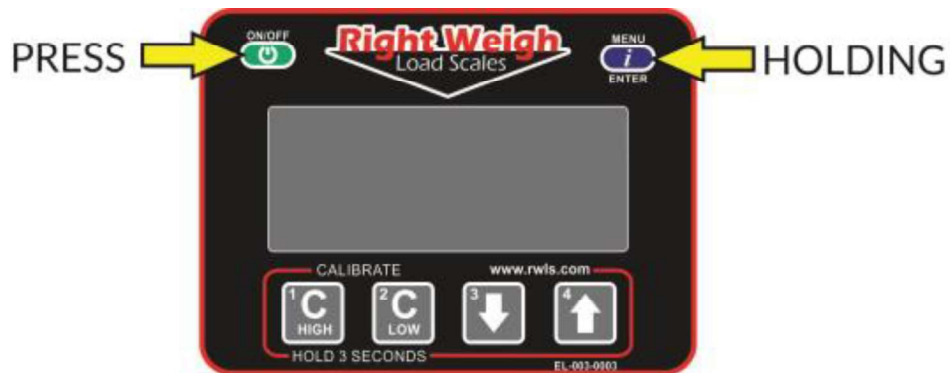

Step 2: Press the  button twice to display the load scale unique identifier.





Step 1: Press (+) from the home screen of the app.



Step 2: If the scale is mounted to a truck, press the truck icon. If mounted to a trailer press trailer icon.

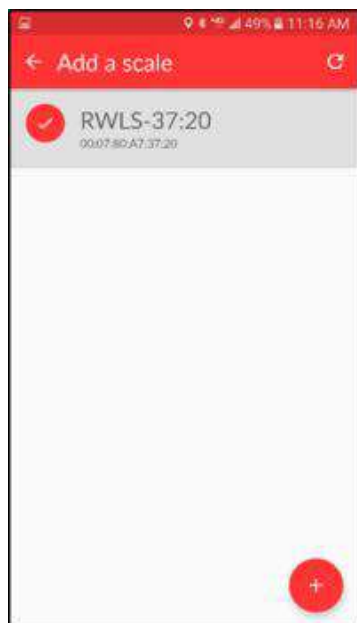

Step 3: Select the load scale matching the unique identifier of the scale you wish to sync with. Tap (+)

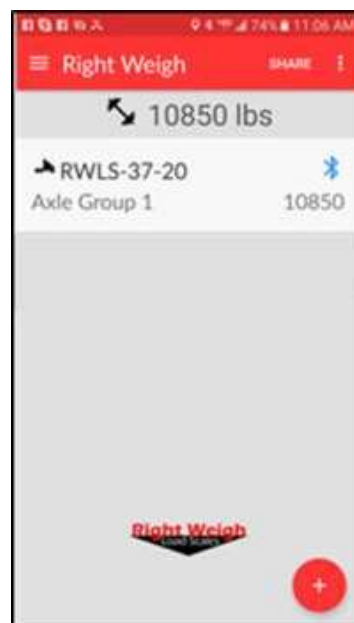

Step 4: The axle group weight will now appear on the home page of the app.

Syncing your Device



Step 1: Press (+) from the home screen.

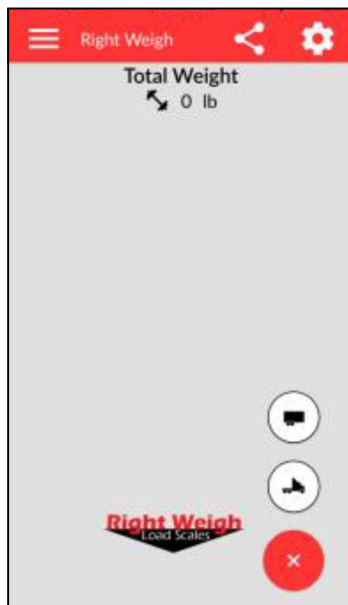

Step 2: If the scale is mounted to a truck, press the truck icon. If mounted to a trailer press trailer icon.



Step 3: Select the load scale matching the unique identifier of the scale you wish to sync with. Tap (+)

If your gauge is setup in the default **Average Mode (AVG)**, you will see the axle group weight displayed.

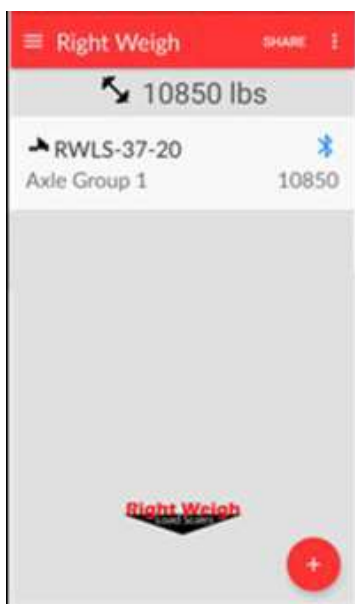

If your gauge is setup in the **Estimated Steer Mode Average (S-AVG)**, you will see the estimated steer axle and drive axle weight.

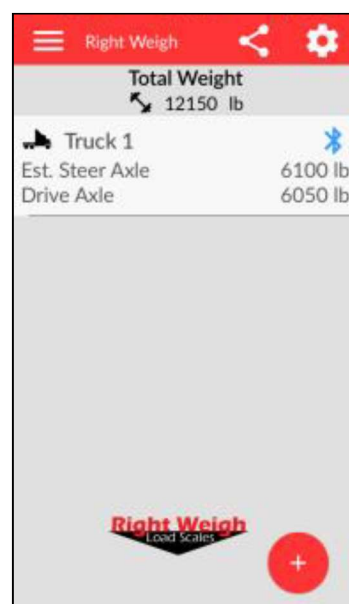

If your gauge is setup in **Multiple Configuration Mode (4CAL)**, you will see all of the configurations available. The inactive configs will be

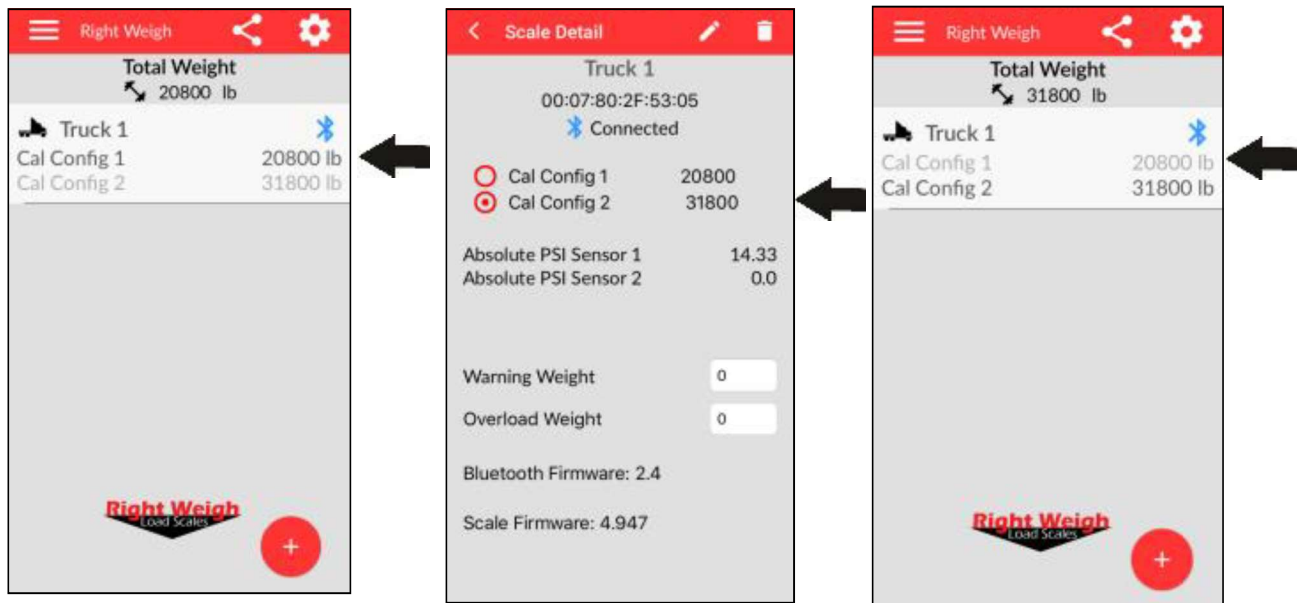

To switch the active configuration, select the load scale on the home screen then select the desired configuration. Press the back arrow.

Set the Load Scale Name

To re-name a scale, tap on the name of the scale from the home screen of the app. Enter the new name, and press return in the keypad. The name you enter will be saved to the scale itself, and will replace the default name. When syncing with your scale in the future, this name will display in the app.



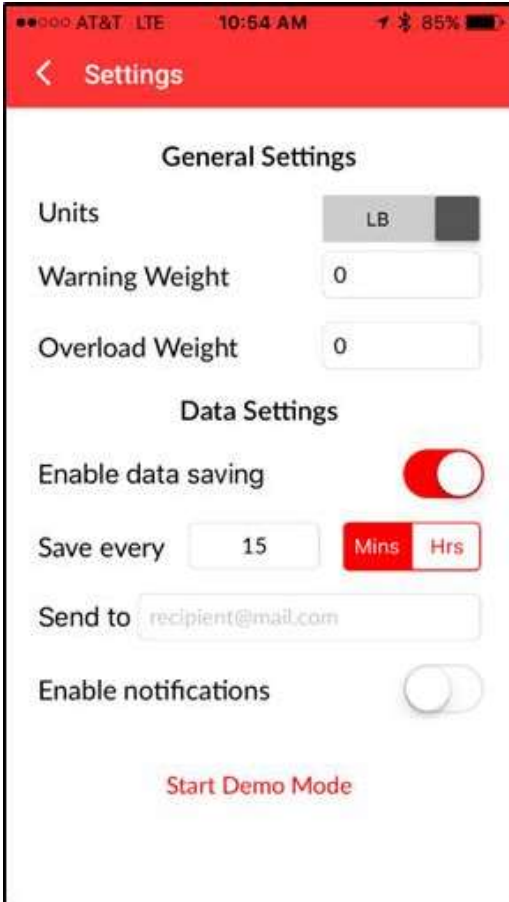

Settings View

In the setting view screen, you have the option to switch between LBS and KG. Furthermore, you can toggle the system support page on startup of application.

Share View

To share your current loaded weigh with others via e-mail or text, tap the share button in the top right corner of the home screen. The share data interface will appear. Choose e-mail or text and enter the contact information of the person you wish to send your data to and press send.

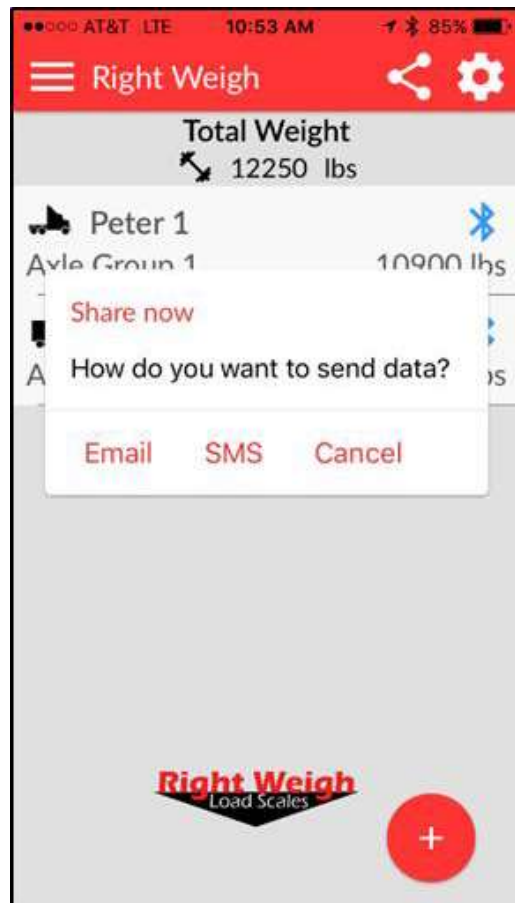

Troubleshooting

Erratic or inaccurate readings

The vehicle is not parked on a level	Parking on sloped or banked surfaces will cause the vehicle weight distribution to shift between the axle groups.
The vehicle's brakes are on	When the vehicle brakes are set, they could apply additional pressure or torque on the suspension air bags. This will cause the suspension to have a different air pressure than what is actually needed to hold up the given weight.
The vehicle is parked on an uneven or rough surface	If one or more of the vehicle's wheels are in a pothole, that could result in additional pressure or torque on the suspension air bags. This will cause the suspension to have a different air pressure than what is actually needed to hold up the given weight.
The height control valve (HCV) is malfunctioning or broken	If the HCV is not functioning correctly, the air pressure applied to the suspension system could be inconsistent and/or erratic. To test for an HCV problem, acquire a weight reading from the Right Weigh load scale and write it down (refer to scale operating instructions for proper procedure). Drive the vehicle around the block and return to the same location. Acquire a second reading from the Right Weigh load scale. If the two readings are significantly different, then the HCV might be malfunctioning.
There is a significant air leak in the suspension system	This could cause the HCV to refill the suspension at regular intervals to maintain the vehicles ride height. If there is a significant leak, the scale display will slowly decrease in value and then quickly increase in value when the HCV refills the suspension system.
App won't connect to Bluetooth scale	Power cycle scale by removing (turn off) power source and reconnecting power source (turn on).

Scale does not power on:

Scale is not connected to a switched power source of between 9 and 32 volts	If there is a bad connection in the circuit which causes voltage to drop below 9 volts, the scale will not power on. Test the power source with a voltmeter. Scale must be connected to a switched source to allow for occasional software reboot.
Polarity is incorrect	The red wire must be connected to positive, and the black to negative.

Scale Display is Blinking

Current weight is above the alarm limit programed by the user	With scale on, press and hold the 1 & 2 buttons simultaneously. The display will show the alarm limit weight. To remove the alarm weight, set this number to 0 using the down arrow, and then hold 1 & 2 again until the display is cleared.
---	--

Cannot Change Calibration Data

The scale has an active user-defined security PIN.	If the scale is protected with a passcode, the PIN number must be entered before calibration data can be changed. The scale will display "CodE" and the previously set 5 digit PIN number must be entered to change the data.
--	---

Scale will not Calibrate Low

Air Pressure in system is not changing	<p>To enter C/L mode, the 201-EBT-01(B) load scale must see a measurable change in air pressure from when you calibrated high.</p> <ul style="list-style-type: none"> • Make sure you calibrate high while your trailer is near the legal limit, and cal low when the trailer is empty. • Be sure the air line is connected to an air bag and not connected to the main air supply or air brake system.
--	---

Appendix A - Additional Parts

The following is a list of additional parts needed for air line installation. This list is just a suggestion and may not be all of the parts needed for your specific vehicle. Check with your Right Weigh dealer for optional installation kits.

- Approximately 20 to 30 feet (6 to 9 meters) or more of 1/4" rigid air line.
- Street tee fitting. The thread size should match the air bag fitting. (1/4" NPT or 3/8" NPT)
- Male straight air line fitting for 1/4" air line, with a thread size to match the street tee fitting.
- 20 or more zip ties.

1/4 Inch Air Line



Street Tee Fitting



Male Straight Fitting

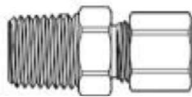

20 or More Zip-Ties



It is very important that all wiring connections be made watertight. Connections which are not watertight will allow moisture to travel through the individual strands of the wires and make it's way into the scale, causing permanent damage to the electronics.

Heat shrinkable splices are included with the 201-SK installation kit.

Crimp each end of the wire into the connector with a wire crimp tool (tool not provided).

With a heat gun or heat torch, heat the connector until it shrinks completely around each wire end. Make sure you do not burn the wire jacket.



After all connections have been made, completely wrap the cable connections with electrical tape, heat shrink tubing, or other environmental protections.

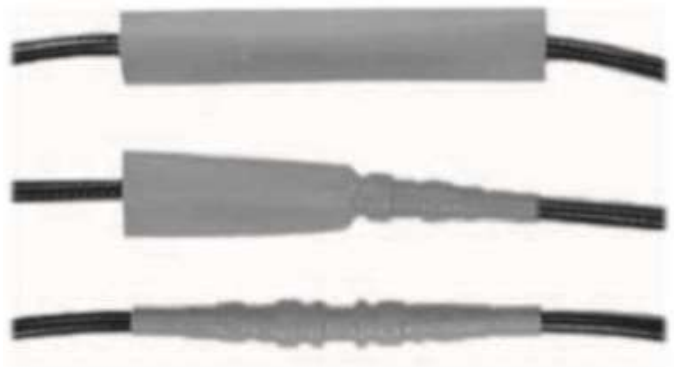

Warranty Statement

Warranty Statement

Right Weigh is committed to providing quality products that function as intended, and we always stand behind our workmanship. Our industry-leading warranty is our best effort to express this commitment. Products manufactured or sold by Right Weigh, Inc. are warranted to be free from significant defects in material and workmanship 3 years from date of purchase. During this time, and within the boundaries set forth in this warranty statement, Right Weigh, Inc. will, at its sole discretion, correct the product problem or replace the product.

This warranty shall not apply to product problems resulting from: (1) Improper application, installation, incorrect wiring, or operation outside of the approved specifications of the product. (2) Accidents, faulty suspension parts or power surges (3) Inadequate maintenance or preparation by the buyer or user (4) Abuse, misuse, or unauthorized modification. (5) Acts of God, lightning strike, floods, fire, earthquake, etc.

Right Weigh, Inc. assumes no responsibility or liability for any loss or damages resulting from use of Right Weigh, Inc. products.

In no event shall Right Weigh, Inc. be liable for direct, indirect, special, incidental or consequential damages (including loss of profits or loss of time) resulting from the performance of a Right Weigh, Inc. product. In all cases, Right Weigh, Inc. liability will be limited to the original cost of the product in question. Right Weigh, Inc. reserves the right to make improvements in design, construction, and appearance of products without notice. Right Weigh, Inc. may at its sole discretion discontinue support, warranty, or repair of products which it deems are obsolete or for which repair parts are no longer available. No employee or agent of Right Weigh, Inc. has the authority to modify the terms of this warranty in any manner whatsoever without the express written permission of Right Weigh, Inc.

Return Policy and Authorization

Before returning any product, please obtain a Return Merchandise Authorization number (RMA#) by calling Customer Service at 888-818-2058 or e-mailing rwls@rwls.com. Include the RMA# and information regarding the reason for the return with the returned product. Shipping costs for returns must be prepaid by the customer. For your protection, items must be carefully packed to prevent damage in shipment and insured against possible damage or loss. Right Weigh, Inc. will not be responsible for damage resulting from careless or insufficient packing or loss in transit.

An RMA# must be obtained by the original purchaser before any product can be returned. Only new, unused products may be returned. Installed, used, damaged, modified or customized products can not be returned for credit. Credit will be issued to the original purchaser after evaluation by Right Weigh, Inc.

Repairs/Replacements

An RMA# must be obtained before any product can be returned. Right Weigh, Inc. will evaluate returned products at no charge. If Right Weigh, Inc. determines that the returned product is under warranty it will repair the product or parts thereof at no charge, or if unrepairable, replace it with the same or functionally equivalent product whenever possible. Right Weigh, Inc. will return the product at its expense via a shipping method (carrier to be at sole discretion of Right Weigh, Inc.) equal to or faster than the method used by the customer. Products or parts thereof not covered by warranty will be repaired or replaced at customer expense upon authorization by the customer. Right Weigh, Inc. will return the repaired product at customer expense via a shipping method (carrier to be at sole discretion of Right Weigh, Inc.) equal to or faster than the method used by the customer.

For additional support contact:

United States, Canada and All Other Countries:

Right Weigh, Inc.
Tel: (888) 818-2058
www.rwls.com
rwls@rwls.com

Australia and New Zealand:

Smart Truck Solutions
Tel: 0418 622840



PP-003-0010 Rev G

June 2017

Right Weigh, Inc.

Hillsboro, Oregon, USA

www.rwls.com

©2015 Right Weigh, Inc. All rights reserved.