



# Installation & Operation Manual



**ONBOARD LOAD SCALE**  
EXTERIOR DIGITAL | 201-EBT-02(B)



Thank you for choosing to drive more and scale less! Here at Right Weigh, we are committed to making our products simple to install and easy to use. We understand that installation can vary between vehicles and yours may not be described in this manual. In any event, our technical support team is ready to answer your questions!



(503) 628-0838  
(888) 818-2058 - Toll Free (USA ONLY)



[support@rwls.com](mailto:support@rwls.com)



[www.rwls.com/how-to-calibrate-install/](http://www.rwls.com/how-to-calibrate-install/)

## IMPORTANT!

Please read instructions **COMPLETELY** and thoroughly before installation. Right Weigh, Inc. is not responsible or liable for product failure or vehicle damage due to improper installation. The installation requirements are outlined in this manual and should be followed thoroughly to avoid inaccuracy or damage to the product.

It is also important to be aware of vehicle manufacturer policies before making modifications to the vehicle. Right Weigh, Inc. is not liable or responsible for issues regarding warranties with other manufacturers. This is the responsibility of the customer. If you are unsure about how these installation practices apply to your vehicle, please contact your vehicle or component manufacturer.

Specifications & Overview	4
Scale Installation and Electrical Connections	7
Drop & Hook Trailers	11
Operating Modes	13
Sensor Average Mode (AVG)	14
Multiple Calibration Mode (4CAL)	14
Estimated Steer + Sensor Average Mode (S-AVG)	15
Independent Mode (IDP)	16
Estimated Steer + Independent Mode (S-IDP)	16
Calibration & Unit of Measure	17
Security PIN Code	19
Set	19
Change	20
Operate & Weigh	21
Right Weigh Bluetooth™ App	22
Connect To Scale	22
Home	24
Scale Details	26
Settings	27
Maintenance	28
Troubleshooting	30
Appendix A - Additional Parts	32
Appendix B - Wiring Insulation	33
Appendix C - General App Information	34
Notes	35
Warranty Statement	38
Return Policy & Repairs	39

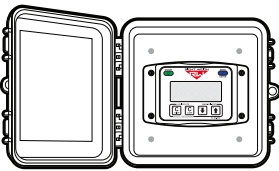

**ONBOARD LOAD SCALE**  
EXTERIOR DIGITAL | 201-EBT-02(B)



The Bluetooth® word mark and logos are registered trademarks owned by Bluetooth SIG, Inc. and any use of such marks by Right Weigh, Inc. is under license. Other trademarks and trade names are those of their respective owners.

The Right Weigh 201-EBT-02(B) digital load scale has two internal air pressure sensors. This scale will monitor one air suspension axle group with two Height Control Valves (HCV) or two axle groups with one HCV each. An axle group can be either a single, tandem, or triple set of axles on the truck or trailer.

### One Axle Group with 2 HCVs

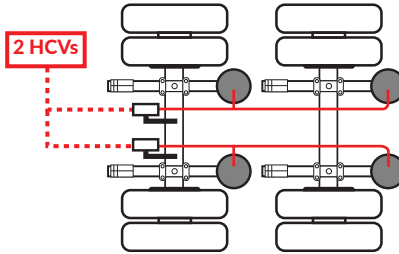

### Two Axle Groups with 1 HCV Each

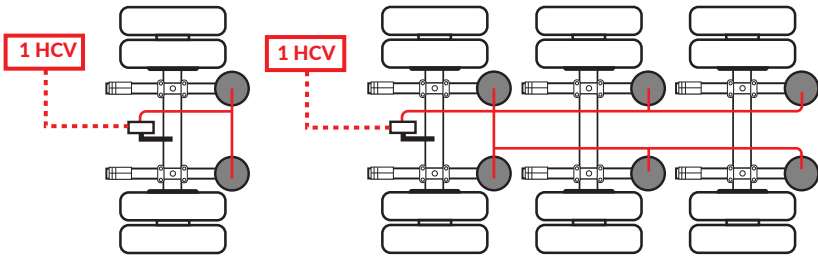

## Drop Axle:

This load scale can be used to monitor one axle group with an air ride lift axle if the lift axle air bags are controlled by the same height control valve as the other axles in the group. The scale will need to be setup using multiple calibration mode. Refer to the Multiple Calibration Mode section for more information.



Independently regulated lift axles cannot be considered part of an axle group and must be in the UP position when calibrating and weighing.

### Estimated Steer Axle:

The weight of the steer axle can be estimated if this scale is used to monitor a tractor's drive axle group. Refer to the Sensor Average + Estimated Steer Mode for more information.

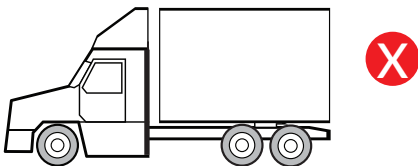
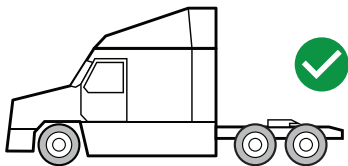

Estimated Steer is for use on tractors only, it will NOT work on straight trucks. Re-calibration is required after changing the position of a sliding fifth wheel.

To monitor the steer axle weight on a straight truck, you will need the 201-EBT-12B.

### Drop & Hook Trailer:

When installed on a tractor's drive axle group, this load scale can also be used to monitor the trailer axle group for a connected trailer. Refer to the Drop & Hook Trailer section for more information.

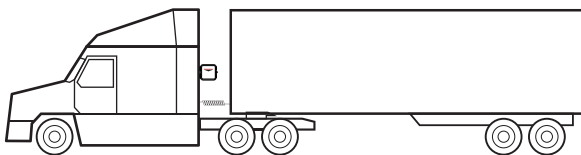
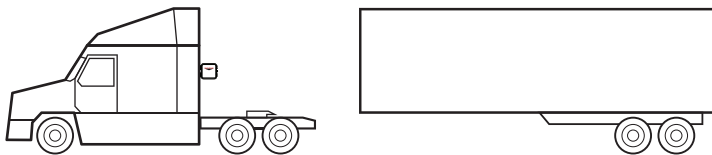



## Technical Specifications:

Operating Temperature: -22° F to +185° F (-30° C to +85° C)

Storage Temperature: -40° F to +185° F (-40° C to +85° C)

Power Requirement: 9 VDC to 32 VDC (Switched)

Units: Pounds (LBS) or Kilograms (KG)

Housing: High impact polycarbonate blend

Display: 0.8" LCD sunlight readable

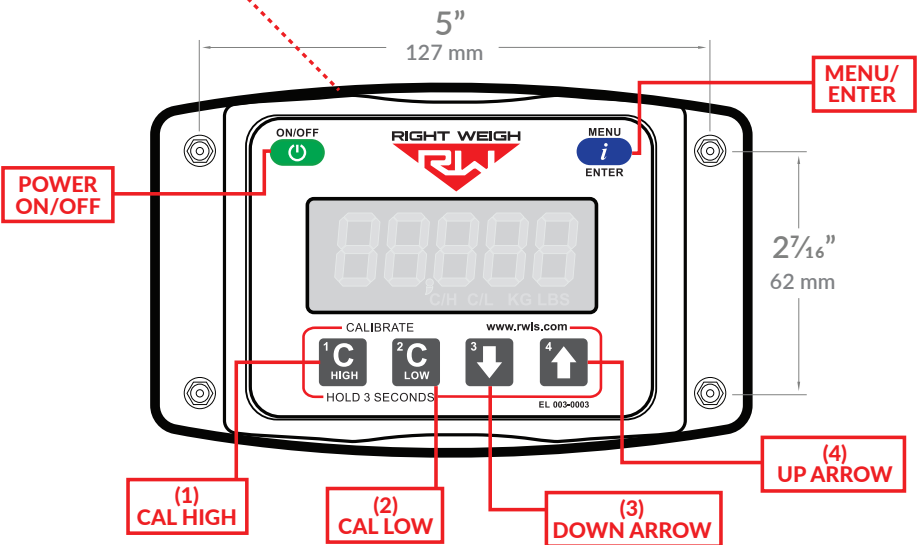
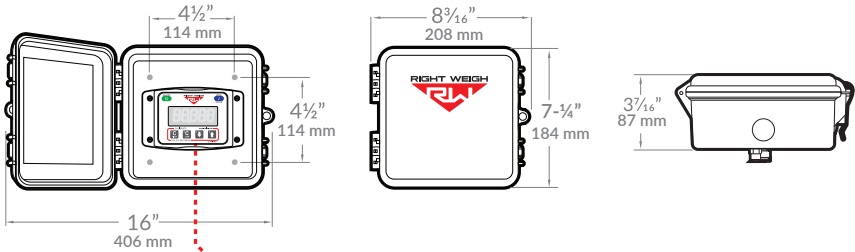

The 201-EBT-02 scale is designed to be mounted on the outside of a truck or trailer, however it must still be mounted in a protective enclosure. A protective box and mounting bracket are included with the 201-EBT-02B.

The following steps will walk you through how to correctly mount and install the scale. Be sure to choose a location that is easily accessible and safe from potential damage (forklift posts, tire caps, etc.)

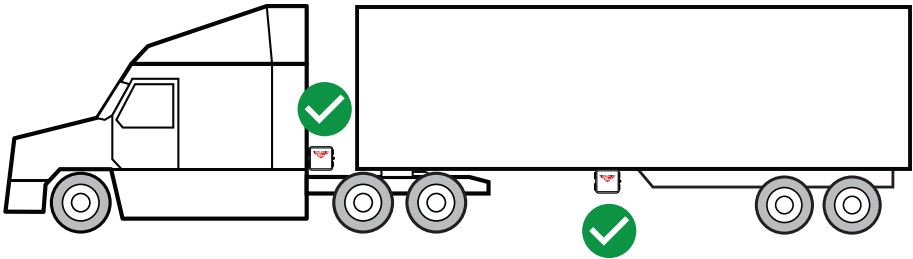

**DO NOT** mount the scale directly to the chassis or any other main beam unless it is approved by the vehicle manufacturer. Doing so may void the warranty with the vehicle manufacturer.

## 1 CHOOSE LOCATION

Make sure the location chosen is easily accessible and safe from potential damage (forklift posts, tire caps, etc.). Mount the bracket in the chosen location and install the gauge box to the bracket using supplied hardware.

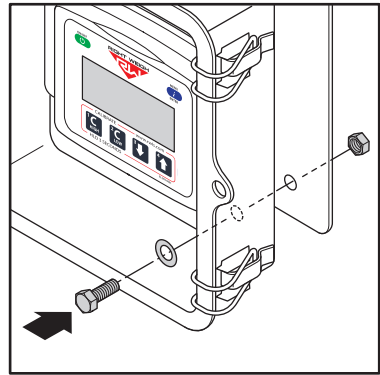

Make sure to use **BOTH** supplied mounting bolts to secure the bracket to the vehicle. Using only one bolt can result in a cracked bracket and the scale falling off the vehicle.

## 2 DUMP AIR FROM SUSPENSION SYSTEM

## 3 INSTALL NEW STREET TEE FITTING

Remove the suspension air line fitting from the top of one of the air bags.



Insert a street tee fitting into the top of the air bag that matches the thread size of the vehicle suspension. Reinstall the suspension air line and fitting into the street tee. For more information on the parts needed for air line installation, see Appendix A.

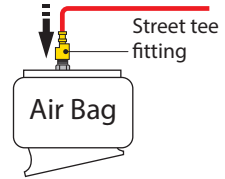

## 4 INSTALL NEW 1/4" AIR LINE

Install a new 1/4" air line and fitting into the remaining port on the tee.



## 5 ROUTE AIR LINE TO GAUGE

Route the new 1/4" air line from the tee fitting assembly to the gauge. Secure air line with zip ties. Insert the air line into the push-to-connect fitting on the back of the gauge. **DO NOT ROTATE THE AIR FITTING!**



Air fittings are directly connected to the internal circuit board. Applying ground(-) or positive(+9-32) voltage to air fittings will cause immediate air sensor failure!

## 6 REPEAT STEPS 3-5 WITH SECOND HCV

A second air line should go from an air bag connected to the second HCV to fitting B on the back of the gauge. For a dedicated tractor-trailer set, fitting A should connect to the drive axle group and fitting B should connect to the trailer axle group.

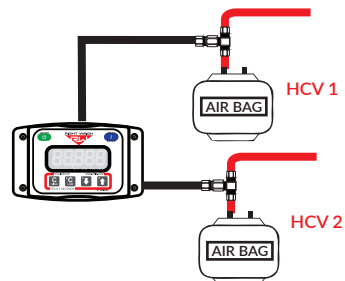



## 7 INSTALL CONNECTION HARNESS

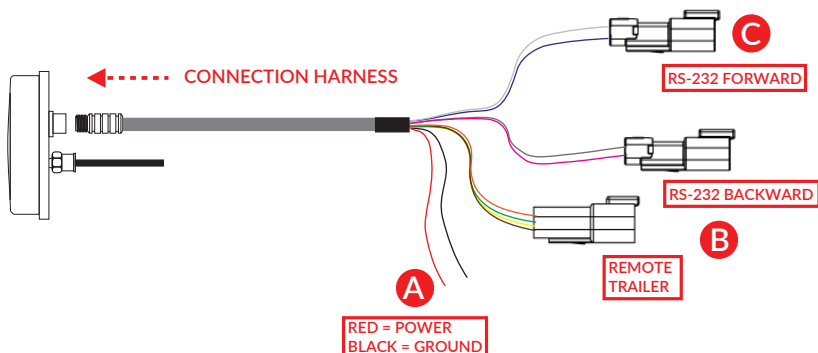

Insert the male 12 pin connector on the harness onto the female connector on the back of the scale. Make sure to orient the connector properly so that the small cutout on both connectors line up. Once the connector has been pressed in, thread the collar into the scale until it is hand tight.

### A POWER CONNECTION

The two unterminated wires coming out of the harness are used to power the scale. Connect the **RED** wire to a switched positive (+) power source and the **BLACK** wire to chassis ground (-). The required supply voltage must be between 9 and 32 volts DC. For more information on wiring connection and insulation, see Appendix B.



DO NOT connect directly to a battery or any constant power source, gauge should be connected to a switched source so that it can be disconnected from power when not in use. Most users connect the power to vehicle marker lights or the AUX/ABS wire.

Electrical connections **MUST** be insulated, see Appendix B for instructions.

## **B** REMOTE TRAILER / RS-232 BACKWARD CONNECTION (OPTIONAL)

These connections are used to send data to and from a Right Weigh Drop & Hook Trailer sensor or other Right Weigh gauge (use is optional, see page 13 for more information). Connect these to the Remote Trailer connection harness included in kit 224-SK if using the Drop & Hook Trailer feature. For more information on this feature, please contact Right Weigh technical support listed on page 2.

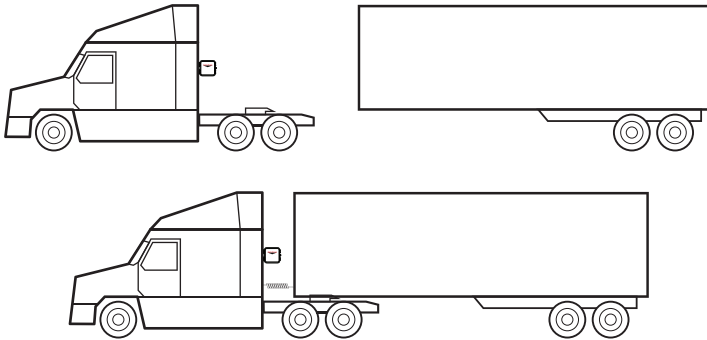

## **C** RS-232 FORWARD CONNECTION (OPTIONAL)

This connection is for RS-232 communication (use is optional). Use this to connect the gauge to a telematics device that supports RS-232 communication. For more information about this feature, please contact Right Weigh technical support listed on page 2.

When installed on a tractor's drive axle group, the 201-EBT-02(B) can also display a trailer axle group weight if used in conjunction with Right Weigh Remote Trailer sensor (RTSK-01\*) and connection harnesses (224-SK\*\* & EL-004-0049\*\*). The 224-SK and EL-004-0049 connection harnesses must be installed on the tractor to allow for connection to the remote trailer sensor. Additionally, an RTSK-01 remote trailer sensor must be installed on each trailer to be monitored.

\*Sold separately

\*\*Included in 201-RTS-02B kit and sold separately

Please refer to the 224-SK and RTSK-01 installation manuals for specific installation instructions for these components.

Follow the steps below to enable and use the Drop & Hook Trailer feature.

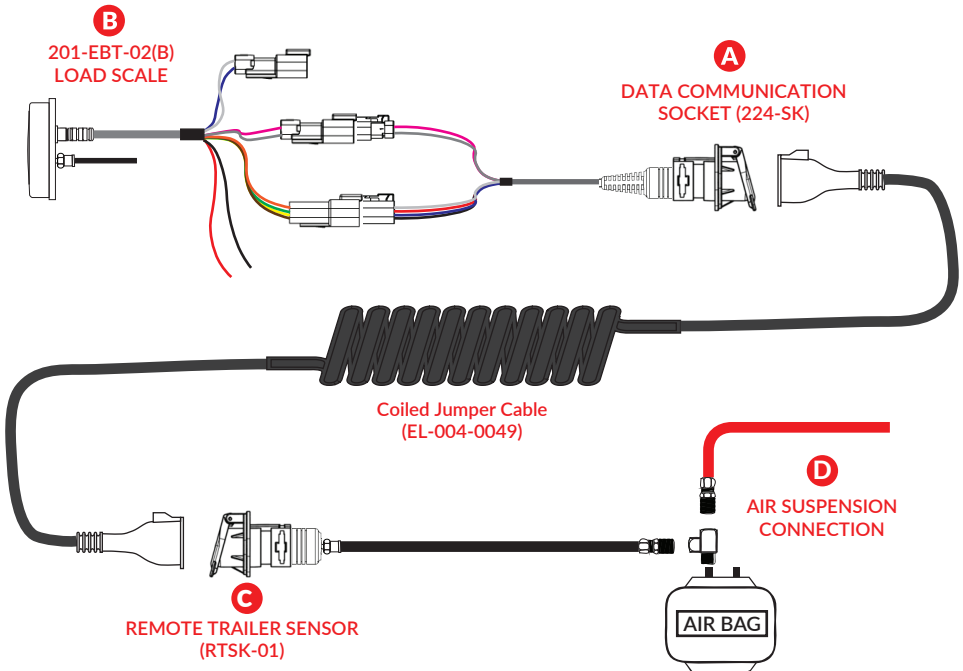
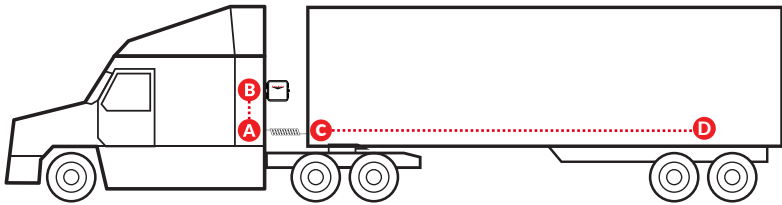

## ENABLE FEATURE ON SCALE

With the scale OFF, press and hold both the UP arrow and MENU buttons and then press the ON/OFF button. Release all 3 buttons. The scale will display "A1". This means the scale has ONE air sensor.



Press the MENU button and the scale will display "rsen0" indicating that Drop & Hook Trailer recognition is off. Press the UP arrow so that the scale displays "rsen1" to turn on Drop & Hook Trailer recognition. To confirm your selection, turn the scale off by pressing the ON/OFF button.



Turning on/off the Drop & Hook Trailer feature will reset any calibration entered into the gauge.

## CONNECT COILED JUMPER CABLE

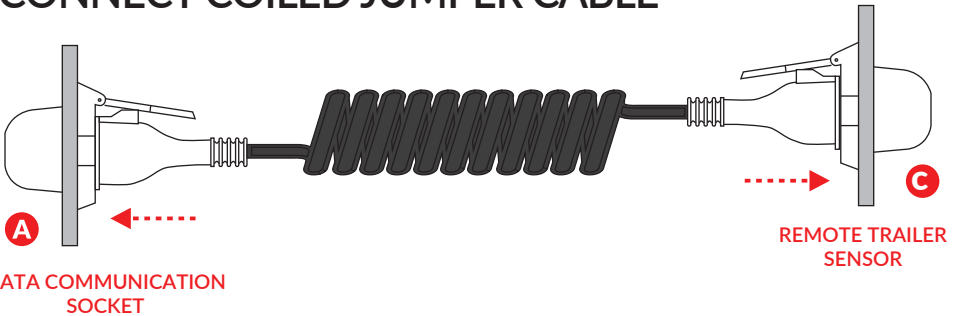

Connect one end of the supplied jumper cable (EL-004-0049) to the data communication socket on the truck and the other end to the remote trailer sensor socket on the trailer. Once this is connected, the scale will display a weight for the trailer axle group. When disconnected from any trailer, the display will read "0" for the trailer axle group. See the Operating Modes section for information on how to identify which axle group is being displayed and how to cycle to the next axle group.

The next few pages cover the operation modes that are built into the 201-EBT-02(B). **The load scale can only be setup in one operating mode at a time. If the mode is changed, the calibration data will be reset to factory defaults, requiring re-calibration.**

- **Sensor Average Mode (AVG):** This is the default mode of the scale. It will display a single weight for an axle group it is attached to. If the scale is connected to a drive axle group with two HCVs and the Drop & Hook Trailer feature has been turned on, this mode will also display a trailer axle group weight.
- **Sensor Average + Estimated Steer Mode (S-AVG):** This mode can be used when the scale is installed to monitor the weight of a tractor's drive axle group with two HCVs. It will display the weight of the drive axle group as well as an Estimated Steer axle weight. Estimated Steer weight is calculated from the calibration data input for the steer axle and the current air pressure reading of the drive axle group. If the Drop & Hook Trailer feature has been turned on, this mode will also display a trailer axle group weight.
- **Independent Mode (IDP):** In this mode, the inputs are separated for monitoring two axle groups with one HCV each.
- **Independent + Estimated Steer Mode (S-IDP):** This mode is used for monitoring a single HCV drive axle group on sensor A, a single HCV trailer axle group on sensor B, and estimating the steer axle weight based on the weight ratio between the drive axle group and the steer axle group.
- **Multiple Calibration Mode (4CAL):** In this mode, four sets of calibration data can be stored for use when monitoring an axle group with more than one operating condition, such as an axle group with an integrated drop/lift axle that shares the same two HCVs. This mode is not available if the Drop & Hook Trailer feature has been turned on.

## CHANGING SCALE MODES

1

With the scale OFF, press and hold both the UP and DOWN arrow buttons, and then press the ON/OFF button. Release all 3 buttons. The scale will display the current mode.



2

Press the UP arrow button to cycle through the operating modes. To confirm your selection, turn the scale off by pressing the ON/OFF button.





## SENSOR AVERAGE (AVG)

### Drop & Hook Trailer Feature Off

In Sensor Average mode, a 201-EBT-02(B) installed on an axle group with two HCVs will display one weight reading for only the axle group it is connected to.



### Drop & Hook Trailer Feature On

If the scale has been installed on a drive axle group and configured to use the remote trailer sensor, the scale will also read out a single weight for the trailer axle group. The small number on the lower left of the display indicates which axle group is being shown. The numbers indicate the following:

- 1 = Drive Axle Group Weight
- 2 = Trailer Axle Group Weight
- 1 2 = Drive + Trailer



Press the MENU button to cycle the display to the next axle group.



DRIVE WEIGHT



TRAILER WEIGHT



TOTAL WEIGHT

## MULTIPLE CALIBRATION MODE (4CAL)

The 201-EBT-02(B) digital load scale in Multiple Calibration mode (4CAL) can store four sets of calibration data. This can be useful for an axle group which has one or more integrated air ride lift axle(s) using the same two HCVs, or a suspension which has many operating conditions. For example, on some 4-axle heavy-haul trailers, there are two fixed axles, a lift axle, and a flip axle all on the same two HCVs. Many operators use calibration set "2" when only two axles are down, calibration set "3" when three axles are down, and calibration set "4" when all four axles are down.



Press the MENU button to cycle the display to the next calibration set.



Multiple Calibration Mode is NOT available for gauges that have the Drop & Hook Trailer feature turned on.

## SENSOR AVERAGE + ESTIMATED STEER MODE (S-AVG)

In Sensor Average + Estimated Steer Mode, a 201-EBT-02(B) installed on a tractor to monitor a drive axle group with two HCVs will also display an estimated steer axle weight. If the scale has been configured to use the Drop & Hook Trailer sensor, it will display a third weight reading for the trailer axle group. The small number on the lower left of the display indicates which axle group is being shown. The numbers indicate the following:

### Drop & Hook Trailer Feature Off

- 1 = Estimated Steer Axle Weight
- 2 = Drive Axle Group Weight
- 1 2 = Estimated Steer + Drive

### Drop & Hook Trailer Feature On

- 1 = Estimated Steer Axle Weight
- 2 = Drive Axle Group Weight
- 3 = Trailer Axle Group Weight
- 1 2 3 = Estimated Steer + Drive + Trailer



Press the MENU button to cycle the display to the next axle group.



(Shown with Drop & Hook Trailer feature off)



Estimated Steer is for use on tractors only, it will NOT work on straight trucks. Re-calibration is required after changing the position of a sliding fifth wheel.

To monitor the steer axle weight on a straight truck, you will need the 201-EBT-11B.



## INDEPENDENT MODE (IDP)

In Independent mode, a 201-EBT-02(B) can monitor the drive and trailer axle groups of a dedicated tractor-trailer set with single HCV's on each axle group. In this mode there is a small number in the lower right of the display indicating the axle group being monitored (1, 2, or 1 & 2 simultaneously).



Use the MENU button to switch the display between the axle groups. Axle group 1 will display the weight associated to sensor A and axle group 2 will show the weight associated to sensor B



DRIVE WEIGHT



TRAILER WEIGHT



TOTAL WEIGHT

## INDEPENDENT + ESTIMATED STEER MODE (S-IDP)

In Independent + Estimated Steer mode, a 201-EBT-02(B) installed on a dedicated tractor-trailer set with sensor A connected to the drive axle group and sensor B connected to the trailer axle group can also estimate the steer axle weight. In this mode, there is a small number in the lower left of the display - either 1, 2, 3, or 1 2 3 simultaneously - to let you know which axle group is being displayed. Axle group 1 displays the estimated steer axle weight, axle group 2 is the drive axle group weight, axle group 3 is the trailer axle weight, and 1 2 3 is the three weights combined.



Use the MENU button to switch the display between the axle groups.



Estimated steer is NOT for straight trucks or anyone who slides their fifth wheel regularly



EST. STEER AXLE



DRIVE WEIGHT



TRAILER WEIGHT



TOTAL WEIGHT





## CHANGING UNITS

With the gauge on, press and hold the UP ARROW and then press the MENU button. This will toggle the settings between pounds and kilograms.



+



## CALIBRATION

The 201-EBT-02(B) load scale must be calibrated both empty and loaded to work properly. The scale associates the weight you enter with the air pressure in the suspension system at the time of calibration. You will need to calibrate once while the vehicle is empty, and again while the vehicle is loaded for each axle group being monitored.



Only enter on-the-ground weight of axle or group being monitored. DO NOT use gross weight, tare weight, etc.

## EMPTY CALIBRATION POINT

1: While the vehicle is empty, obtain axle group weights from a certified in-ground scale.

2: Park on a level surface. Shift the transmission to neutral and set the parking brakes. Chock the wheels to prevent unexpected vehicle movement, then release the parking and service brakes.

3: Make sure the Height Control Valve (HCV) has fully inflated the air bags. If needed, briefly dump the air from the suspension and allow the HCV to refill the system.



4: Press the ON/OFF button to turn on the Right Weigh load scale.



5: Press the blue MENU button to select the proper axle group or calibration set.



6: Press and hold the C LOW button until the "C/L" symbol appears.



7: Adjust the value using the UP and DOWN arrows so that it matches your scale ticket for the axle group.



8: To save, press and hold the C LOW button until the "C/L" symbol disappears.

9: Repeat steps 5-8 for all axle groups or calibration sets.

## LOADED CALIBRATION POINT



Repeat "empty calibration point" steps 1-3 with the vehicle fully loaded.



4: Press the ON/OFF button to turn on the Right Weigh load scale.



5: Press the blue MENU button to select the proper axle group or calibration set.



6: Press and hold the C HIGH button until the "C/H" symbol appears.



7: Adjust the value using the UP and DOWN arrows so that it matches your scale ticket for the axle group.



8: To save, press and hold the C HIGH button until the "C/H" symbol disappears.

9: Repeat steps 5-8 for all axle groups or calibration sets.

## RE-CALIBRATION

It is recommended to re-calibrate every 6 months for each axle group being measured.

## 1

With the gauge off, press and hold both the C LOW and C HIGH buttons, then press the ON/OFF button. Release all three buttons. The gauge will display "CodE".

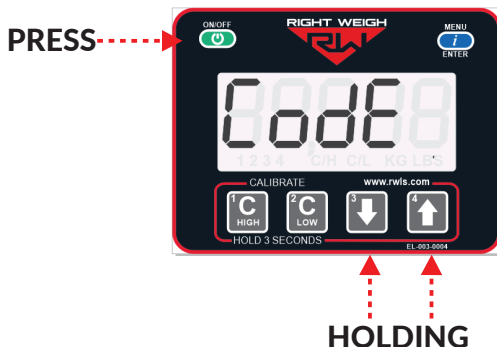

## 2

Press the MENU button and "00000" will display on the screen. Enter a 5 digit PIN code using the 1, 2, 3, and 4 buttons. Press the MENU button again to save the code.

\*\*If the display shows "-----", then there is already a code set. See next page to change existing PIN code\*\*



# CHANGE SECURITY PIN CODE



1

With the gauge off, press and hold both the C LOW and C HIGH buttons, then press the ON/OFF button. Release all three buttons. The gauge will display "CodE".

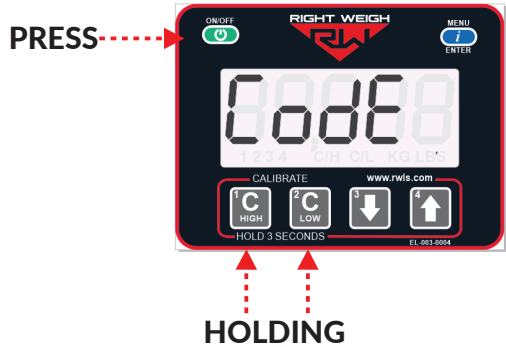

2

Press the MENU button and "-----" will display on the screen. Enter the previous PIN code. If the code entered is correct, the display will show "Good".



3

Press the MENU button and enter the new 5-digit PIN code using the 1, 2, 3, and 4 buttons. Press the MENU button again to save the code.



Follow these steps while weighing your vehicle:

1: Park on a level surface. Shift the transmission to neutral and set the parking brakes.

2: Chock the wheels to prevent unexpected vehicle movement, then release the parking and service brakes.

3: Make sure the Height Control Valve (HCV) has fully inflated the air bags. If needed, briefly dump the air from the suspension and allow the HCV to refill the system. (This may take several minutes depending on the type of HCV.)



4: Press the ON/OFF button to turn on the Right Weigh load scale.

5: Adjust the suspension or the load itself until the Right Weigh load scale displays a weight value below your legal limit.



6: Press the blue MENU button to display other axle groups or calibration sets.



7: Press the ON/OFF button to turn off the Right Weigh load scale.



Go to the Google Play or App Store and download the Right Weigh App!

Once the Right Weigh Load Scale app has been downloaded onto your smart device, follow these steps to connect to your scale.

1

With the gauge off, hold down the MENU button, press the ON/OFF button, and release both simultaneously.

PRESS



HOLD

2

Press the MENU button twice to see the unique identifier. This identifier will appear in the factory-set scale name and the scale ID displayed in the app.

PRESS  
x2



3

Once the app has been downloaded and opened, you will see the home screen with no gauge connected to it and a gross weight of "0".

The Bluetooth connection range is between 100 to 250 feet or more, depending on the device brand and version, line of sight to the scale, and material interferences. A direct line-of-sight with no metal or concrete interference will provide the best possible signal. Metal or concrete obstructions will reduce the signal strength. Signal strength further degrades as more or thicker obstructions are added between the smart device and the load scale.

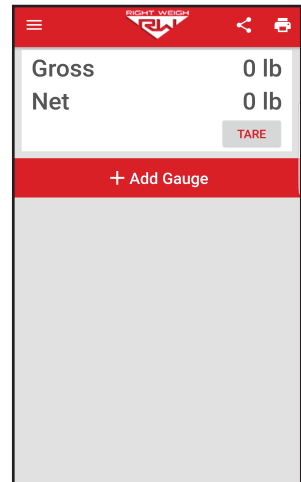

## 4

On the app home screen, press the “Add Gauge” button and choose whether the gauge is connected to the truck or trailer.

If you are adding more than one gauge, be sure to add the truck gauge first and then add the trailer gauges in order from front to back.

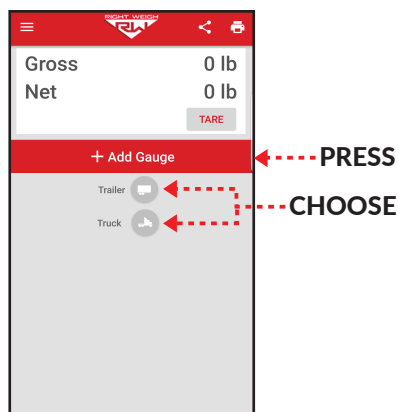

## 5

Look for the gauge with the name containing the unique identifier found in step 2. Select the appropriate gauge to add it to the home screen.

When connecting to more than one scale, the scales should be added in front to back order of how they appear on the vehicle. See Appendix C for more information.

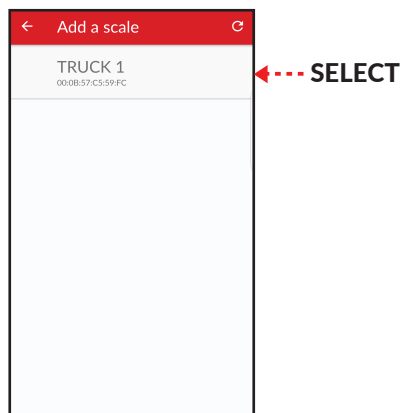



## HOME SCREEN

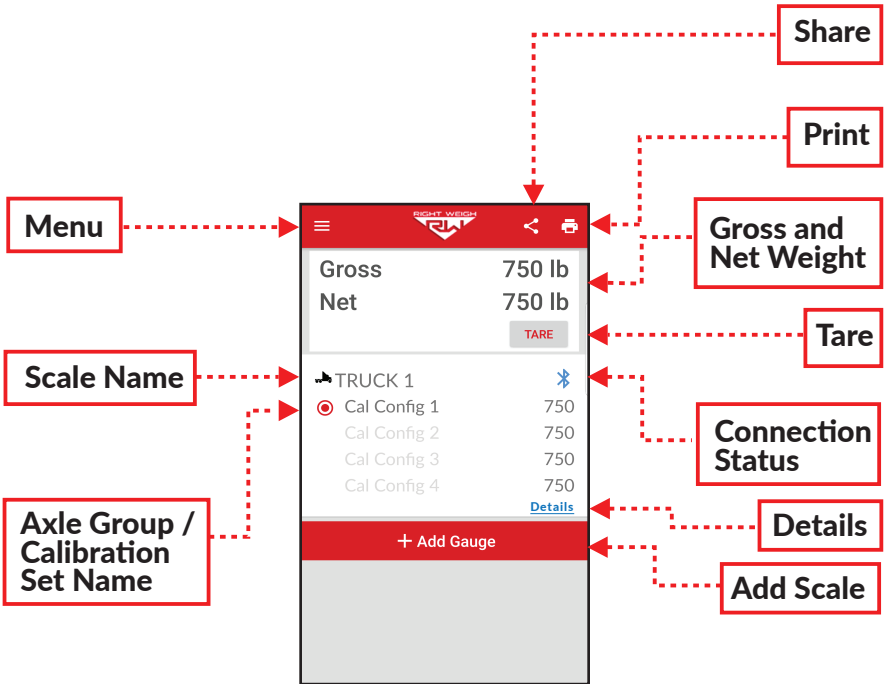



## MENU

The menu button opens a menu with three selections:

**View Data** - view the data logged by the data saving feature found under Settings.

**Settings** - see page 29 for more information.

**Contact Us** - contact Right Weigh technical support.

The app version number is also displayed at the bottom of the menu.

## SHARE

The share icon will allow you to send your weight data via email or text message.

## PRINT

The print icon will allow you to print a weight receipt to most Bluetooth "POS" receipt printers with your weight data and location on it.

## GROSS AND NET WEIGHT

Gross weight is the total weight of all monitored axle groups from all connected gauges. Net weight is the net change in gross weight since the tare button was last pressed.

## TARE

Pressing the "TARE" button will zero the net weight. Press "TARE" before loading to see how much commodity has been loaded on the vehicle. All of the vehicle's axles must be monitored for a correct gross or net weight.

## SCALE NAME

Once you have connected the gauge to your phone app, the scale name will display here.

## AXLE GROUP / CALIBRATION SET NAME

These names represent either the axle groups or calibration sets being monitored and are dependent on the operating mode of the scale.

## CONNECTION STATUS

A blue icon means the scale is connected. If the icon is gray, the scale has been disconnected or is out of range and pressing the refresh icon will allow the app to attempt to reconnect. See Appendix C for more information on connection status.

## DETAILS

Clicking on the Details button will send you to a details page with more information on the scale status and will allow you to set the scale name.

## ADD SCALE

Once your scale has been connected to power, click the "+ Add Gauge" button to scan for and connect to each scale on your vehicle. Be sure to add them in the order they are connected on your vehicle from front to back.

To get to the scale details screen:

iOS devices: press the details link shown below the axle weights on the home screen.  
Android devices: press on the scale name shown on the home screen.

This page will display information for that specific scale and includes the ability to rename the scale.

## SCALE NAME

To re-name the scale, select the pencil icon to the right. When finished, press "OK" to save. If the name doesn't change, try deleting the scale and re-adding it on the app

If there is a PIN code previously set on the gauge, follow steps 1 and 2 on page 21 to unlock the gauge before beginning

## SCALE INFORMATION

Under the scale name, you can find the scale's unique identifier, firmware version, and Bluetooth version

## WARNING AND OVERLOAD WEIGHTS

These weights are typically set in the "Settings" menu of the app, but here they can be overwritten for each scale individually

## SENSOR VALUES

Here you can find the psi value for each air sensor. Weight information will also be displayed below these values

## DELETE SCALE

Select this icon to disconnect the scale from the device and remove it from the home screen

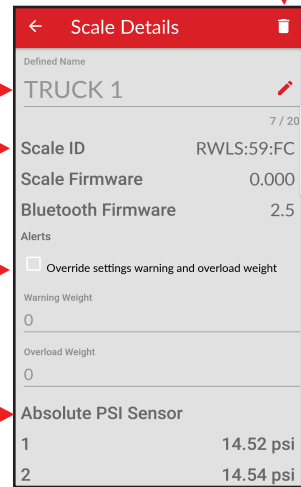

Android App Shown

To get to the settings screen, press the menu button on the top left of the home screen and navigate to "Settings"

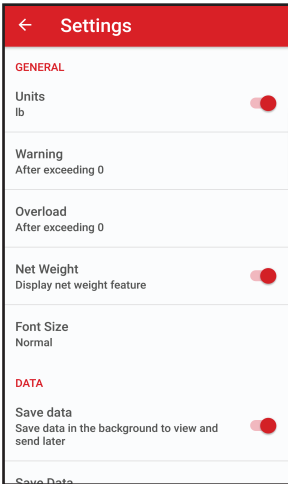

Android App Shown

## CHANGING UNITS

Change the units to either pounds (LB) or kilograms (KG)

## SET WARNING AND OVERLOAD WEIGHTS

Set warning and overload weight limit defaults

## NET WEIGHT

Toggle the net weight feature on/off. The net weight feature is an additional weight display on the home screen that shows net change in gross weight since the "TARE" button was last pressed. Pressing "TARE" does not affect calibration and can be pressed anytime

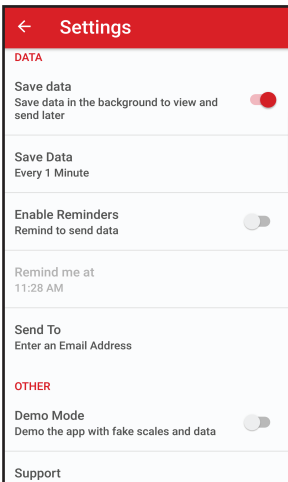

Android App Shown

## DATA SAVING

Specify data saving and where to send the information to

## DEMO MODE

Turn on demo mode to see all the app features without connecting to a gauge



To be sure the gauge remains accurate, proper maintenance and re-calibration is recommended every 6 months or when changes/repairs to the suspension have taken place.

Follow the steps below to check gauge functionality. Once this is complete, re-calibrate the gauge; it is important to re-calibrate for each axle group being measured.

## MAINTENANCE

With the gauge off, hold down the MENU button, press the ON/OFF button, and release both simultaneously. This will take you to "Diagnostics Mode". Once the screen turns on, press the MENU button to cycle through the following screens.



### FIRMWARE #

This screen displays the firmware # programmed on the gauge.



### SCREEN CHECK

On this screen, all characters should be lit up.



### UNIQUE IDENTIFIER

This screen displays the unique identifier programmed on the gauge. This is the number you will see when connecting to a Bluetooth device for the first time.

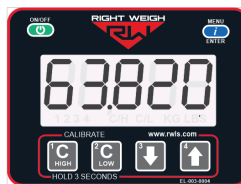

### AIR PRESSURE

This is the air pressure reading from the internal air pressure sensor. It should be between 18 and 90 (PSIA) with the suspension fully inflated.



## BAROMETRIC PRESSURE

This screen displays the barometric pressure sensor reading and should be between 13 and 16 (PSIA).







## OPERATING MODE

This is the operating mode the gauge is configured in.



## KEYPAD TEST

This screen will show "PAD 0" and pressing each of the buttons should show a separate number listed below:

-  = PAD 1
-  = PAD 2
-  = PAD 3
-  = PAD 4
-  = PAD 5

Pressing the blue MENU button again will return the gauge to the firmware # screen. From here you can press the green ON/OFF button to turn off the scale and exit "Diagnostics Mode".



If the gauge fails any of these steps (or you find that the gauge is inaccurate after re-calibration) please call Right Weigh technical support for assistance.



PROBLEM	CAUSE	SOLUTION
Erratic / Inaccurate Weight Readings	The vehicle is not parked on a level surface	Park on level concrete ground. Parking on sloped or banked surfaces will cause the vehicle weight distribution to shift between the axle groups. Additionally, if one or more of the vehicle's wheels are in a pothole, that could result in additional pressure or torque on the suspension air bags. This will cause the suspension to have a different air pressure than what is normally needed to hold up the given weight.
	The vehicle's brakes are on	Release the parking brakes when weighing and/or calibrating. When the vehicle brakes are set, they could apply additional pressure or torque on the suspension air bags. This will cause the suspension to have a different air pressure than what is normally needed to hold up the given weight.
	There is a significant air leak in the suspension system	Check air lines for leaks. Having a leak could cause the HCV to refill the suspension at regular intervals to maintain the vehicle's ride height. If there is a significant leak, the gauge display will slowly decrease in value and then quickly increase in value when the HCV refills the suspension system.
	The Height Control Valve (HCV) is malfunctioning or broken	If the HCV is not functioning correctly, the air pressure applied to the suspension system could be inconsistent and/or erratic. To test for an HCV problem, acquire a weight reading from the Right Weigh gauge and write it down (refer to gauge operating instructions for proper procedure). Drive the vehicle around the block and return to the same location. Acquire a second reading from the Right Weigh gauge. If the two readings are significantly different, then the HCV might be malfunctioning.
Scale Display is Blinking	Current weight is above the alarm limit programmed by the user	With scale on, press and hold the 1 & 2 buttons simultaneously. The display will show the alarm limit weight. To remove the alarm weight, set this number to 0 using the down arrow, and then hold 1 & 2 again until the display is cleared.
App Won't Connect to the Gauge	Scale is connected to a constant power source	Connect the scale to a switched power source between 9 and 32 VDC (typically either the vehicle marker lights or the AUX/ABS wire). If the gauge is powered too long it can stop transmitting a Bluetooth signal and may need to be disconnected and reconnected to work again.
	Scale is connected to another device	Disconnect the scale from the other device before connecting through your device.
	Phone requires re-set	To reset your phone - close the app, turn off Bluetooth, and wait 10 seconds. Then open the app and turn the Bluetooth back on. Try rescanning for the scale. If this still doesn't work, in some cases it is necessary to restart the phone completely.
Gauge Will Not Calibrate Low/High	Air pressure in the system is not changing	To enter low or high cal mode, the gauge must see a measurable change in air pressure. Make sure you calibrate high when the vehicle is near the legal limit and calibrate low when the truck is empty. Also, be sure the air line is connected directly to an air bag - NOT the main air supply or brake system.

PROBLEM	CAUSE	SOLUTION
Scale Does Not Power On	Scale is not connected to a switched power source of between 9 and 32 VDC	Connect the scale to a switched power source between 9 and 32 VDC (typically either the vehicle marker lights or the AUX/ABS wire). If there is a bad connection in the circuit which causes voltage to drop below 9 volts, the scale will not power on. Test the power source with a voltmeter.
	Scale is connected directly to the battery	Connect the scale to a switched power source between 9 and 32 VDC (typically either the vehicle marker lights or the AUX/ABS wire). The scale is active anytime it is connected to power, even if the display is off. To reset it, disconnect and reconnect to the power source, wait 10 seconds, then try again to turn the display on.
	Polarity is incorrect	Correct the polarity. The red wire must be connected to positive and the black to negative.
Cannot Change Calibration Data	The scale has an active user-defined security PIN code	If the scale is protected with a PIN code, the PIN must be entered before calibration data can be changed. To understand how to reset the PIN code, see page 16. If the PIN code has been forgotten, please call Right Weigh technical support listed on page 2 for further assistance.

The following is a list of additional parts needed for air line installation. This list is just a suggestion and may not be all of the parts needed for your specific vehicle. Check with your Right Weigh dealer for optional installation kits.

### 1/4 Inch Air Line

Approximately 20 to 30 feet (6 to 9 meters)

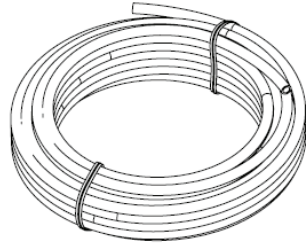

### 20 or more Zip Ties

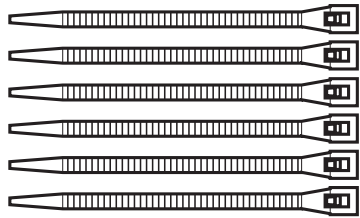

### Male Straight Fitting

Air line fitting for 1/4" air line, with a thread size to match the street tee fitting.

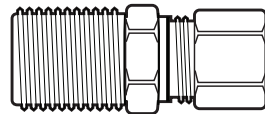

### Street Tee Fitting

The thread size should match the air bag fitting. (1/4" NPT or 3/8" NPT)

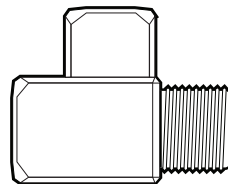



It is very important that all wiring connections be made watertight. Connections which are not watertight can allow moisture to travel through the individual strands of the wires and make it's way into the scale, causing permanent damage to the electronics.

Heat shrinkable splices are included in the 201-SK Installation Kit.

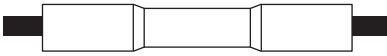

**Crimp each end of the wire into the connector with a wire crimp tool (tool not provided).**

After crimping and heat shrinking



**With a heat gun or heat torch, heat the connector until it shrinks completely around each wire end. Make sure you do not burn the wire jacket.**

Add heat shrink



After heat shrinking



**After all connections have been made, heat shrink the entire group of splices so that it seals on the outer jacket of both cables.**

## GENERAL APP INFORMATION

Be sure to add the scales on the app in the correct order (front to back).

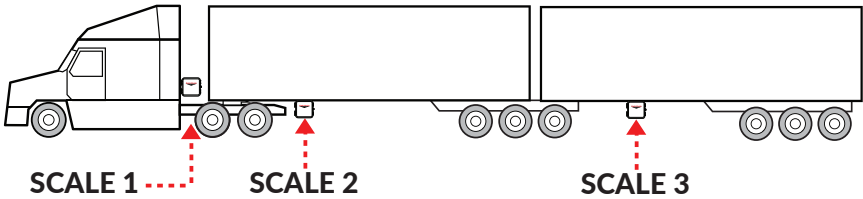

If the trailer scales are in the wrong order, delete them and re-add them in the correct order.

The app can support up to 8 scales at a time. Signal strength is best when the phone has a direct line-of-sight to the scales. Metal obstructions will reduce the Bluetooth range of the system. Make sure that all scales are connected before taking a weight reading. In some cases, it may be necessary to step out of the vehicle to connect to scales that are far away.

Scales can only be connected to one device at a time. If other drivers near by need to connect to the scale, make sure to delete it off the app so that it can be discoverable to other devices. (Delete scales by pressing the “Details” button and selecting the delete scale icon at the top right of the screen. See page 24 for more information.)



If the app shows an improper Bluetooth connection on any of the scales, **DO NOT** use the weight reading. Verify that all gauges are connected before taking a weight reading.

Follow these steps to regain Bluetooth connection:



**CONNECTED**  
(Use)



**NOT CONNECTED**  
(Do Not Use)

Make sure you are within range of the scale and that there is nothing interfering that may block connection.

Make sure the scale is receiving power (if the scale doesn't turn on, check that it is connected to a **SWITCHED** power source).

If another user is connected to the scale, have them delete it off of their app in order for you to connect to it.

Delete the scale from the app and try re-connecting to it.









Right Weigh is committed to providing quality products that function as intended, and we always stand behind our workmanship. Our industry leading warranty is our best effort to express this commitment. Products manufactured or sold by Right Weigh, Inc. are warranted to be free from significant defects in material and workmanship 3 years from date of purchase. During this time, and within the boundaries set forth in this warranty statement, Right Weigh, Inc. will, at its sole discretion, correct the product problem or replace the product.

This warranty shall not apply to product problems resulting from: (1) Improper application, installation, incorrect wiring, or operation outside of the approved specifications of the product. (2) Accidents, faulty suspension parts or power surges (3) Inadequate maintenance or preparation by the buyer or user (4) Abuse, misuse, or unauthorized modification. (5) Acts of God, lightning strike, floods, fire, earthquake, etc.

Right Weigh, Inc. assumes no responsibility or liability for any loss or damages resulting from use of Right Weigh, Inc. products.

In no event shall Right Weigh, Inc. be liable for direct, indirect, special, incidental or consequential damages (including loss of profits or loss of time) resulting from the performance of a Right Weigh, Inc. product. In all cases, Right Weigh, Inc. liability will be limited to the original cost of the product in question. Right Weigh, Inc. reserves the right to make improvements in design, construction, and appearance of products without notice.

## Return Policy and Authorization

Before returning any product, please obtain a Return Merchandise Authorization number (RMA#) by calling Customer Service at 503-628-0838 or e-mailing support@rwls.com. Include the RMA# and information regarding the reason for the return with the returned product. Shipping costs for returns must be prepaid by the customer. For your protection, items must be carefully packed to prevent damage in shipment and insured against possible damage or loss. Right Weigh, Inc. will not be responsible for damage resulting from careless or insufficient packing or loss in transit.

An RMA# must be obtained by the original purchaser before any product can be returned. Only new, unused products may be returned. Installed, used, damaged, modified or customized products can not be returned for credit. Credit will be issued to the original purchaser after evaluation by Right Weigh, Inc.

## Repairs/Replacements

An RMA# must be obtained before any product can be returned. Right Weigh, Inc. will evaluate returned products at no charge. If Right Weigh, Inc. determines that the returned product is under warranty it will repair the product or parts thereof at no charge, or if unrepairable, replace it with the same or functionally equivalent product whenever possible. Right Weigh, Inc. will return the product at its expense via a shipping method (carrier to be at sole discretion of Right Weigh, Inc.) equal to or faster than the method used by the customer. Products or parts thereof not covered by warranty will be repaired or replaced at customer expense upon authorization by the customer. Right Weigh, Inc. will return the repaired product at customer expense via a shipping method (carrier to be at sole discretion of Right Weigh, Inc.) equal to or faster than the method used by the customer.

For additional support contact:

Right Weigh, Inc.

(503) 628-0838

(888) 818-2058 - Toll Free (USA ONLY)

[www.rwls.com](http://www.rwls.com)

[support@rwls.com](mailto:support@rwls.com)



Right Weigh, Inc.  
Hillsboro, Oregon USA

PP-003-0015 Revision H

February 2021

©2015-2021 Right Weigh, Inc. All rights reserved.