



Installation & Operation Manual



ONBOARD LOAD SCALE
EXTERIOR DIGITAL | 201-EBT-04(B)



Scan here to download the Right Weigh App!

Thank you for choosing to drive more and scale less! Here at Right Weigh, we are committed to making our products simple to install and easy to use. We understand that installation can vary between vehicles and yours may not be described in this manual. In any event, our technical support team is ready to answer your questions!



(503) 628-0838
(888) 818-2058 - Toll Free (USA ONLY)



support@rwls.com



www.rwls.com/manuals-resources/

IMPORTANT!

Please read instructions COMPLETELY and thoroughly before installation. Right Weigh, Inc. is not responsible or liable for any negative consequences as a result of improper installation or operation including, but not limited to, product failure or damage that could affect the integrity of the vehicle.

The installation steps in this manual are for the sole use of trained installers. Right Weigh, Inc. accepts no responsibility or liability for issues involving, but not limited to, incorrect installation that occur from misinterpretation of the steps outlined in this document.

It is the end user's responsibility to be aware of vehicle manufacturer policies before making modifications to the vehicle. Right Weigh, Inc. is not liable or responsible for issues regarding, but not limited to, warranties with other manufacturers. This is the responsibility of the end user.

For a more detailed explanation of the the warranty and liability of Right Weigh, Inc. please refer to the "Warranty Statement" and "Return Policy & Repairs" section of this document and www.rwls.com/warranty.

FOLLOW US!



Specifications & Overview	4
Scale Installation and Electrical Connections	7
Operating Modes	10
Tractor	11
Calibration & Unit of Measure	12
Security PIN Code	14
Set	14
Change	14
Operate & Weigh	15
Troubleshooting	16
Appendix A - Additional Parts	18
Appendix B - Wiring Insulation	19
Appendix C - Estimated Steer	20
Notes	21
Warranty Statement	22
Return Policy & Repairs	23

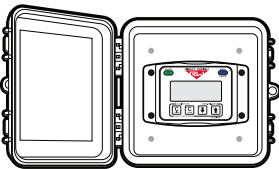

ONBOARD LOAD SCALE
EXTERIOR DIGITAL | 201-EBT-04(B)



The Bluetooth® word mark and logos are registered trademarks owned by Bluetooth SIG, Inc. and any use of such marks by Right Weigh, Inc. is under license. Other trademarks and trade names are those of their respective owners.

The Right Weigh 201-EBT-04(B) digital load scale has four internal air pressure sensors. This scale will monitor one air suspension axle group with four Height Control Valves (HCVs) or four axle groups with one HCV each. An axle group can be either a single, tandem, or triple set of axles on the truck or trailer.

One Axle Group with 4 HCVs

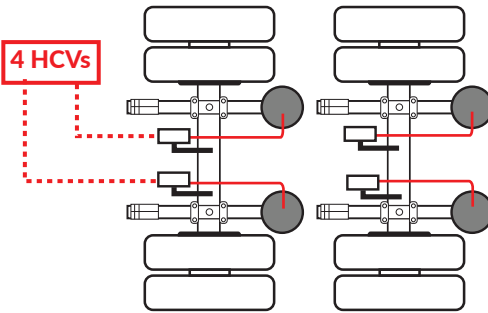

Four Axle Groups with 1 HCV Each

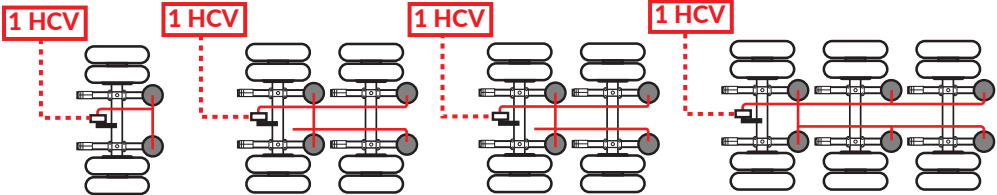

Drop Axle:

This load scale can be used to monitor one axle group with an air ride lift axle if the lift axle air bags are controlled by the same height control valve as the other axles in the group. The scale will need to be setup using multiple calibration mode. Refer to the Operating Modes section for more information.



Independently regulated lift axles cannot be considered part of an axle group and must be in the UP position when calibrating and weighing.

Estimated Steer Axle:

The weight of the steer axle can be estimated if this scale is used to monitor a tractor's drive axle group. Refer to Appendix C for more information.

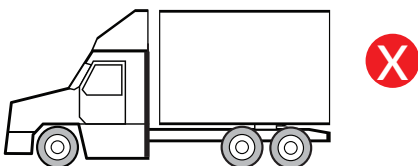
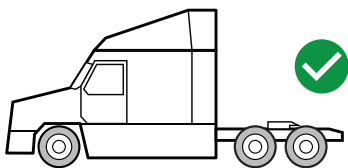

Estimated Steer is for use on tractors with a fifth wheel hitch only, it will NOT work on straight trucks or car haulers. Re-calibration is required after changing the position of a sliding fifth wheel.

Remote Sensor Feature:

The 201-EBT-04(B) scale has the capability of connecting to a Right Weigh Remote Sensor that has been installed on a separate vehicle, most commonly used in drop & hook situations. To use this feature, a separate 403-SK, and RTK-01 or RTK-02 kit must be purchased to connect to a trailer. For more information about this feature, please refer to the 403-SK Instruction Manual or call Right Weigh Technical Support listed on page 2.

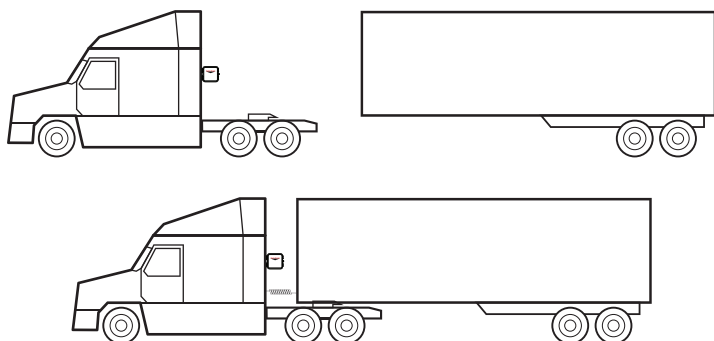

Right Weigh Load Scales App:



Scan here to **download** the "Right Weigh Load Scales" App directly from the App store



Scan here for **instructions** about how to connect to your scale(s) and use the app along with a video tutorial

Technical Specifications:

- Operating Temperature: -22° F to +185° F (-30° C to +85° C)
- Storage Temperature: -40° F to +185° F (-40° C to +85° C)
- Power Requirement: 9 VDC to 32 VDC (Switched)
- Units: Pounds (LBS) or Kilograms (KG)
- Housing: High impact polycarbonate blend
- Display: 0.8" sunlight-readable LCD

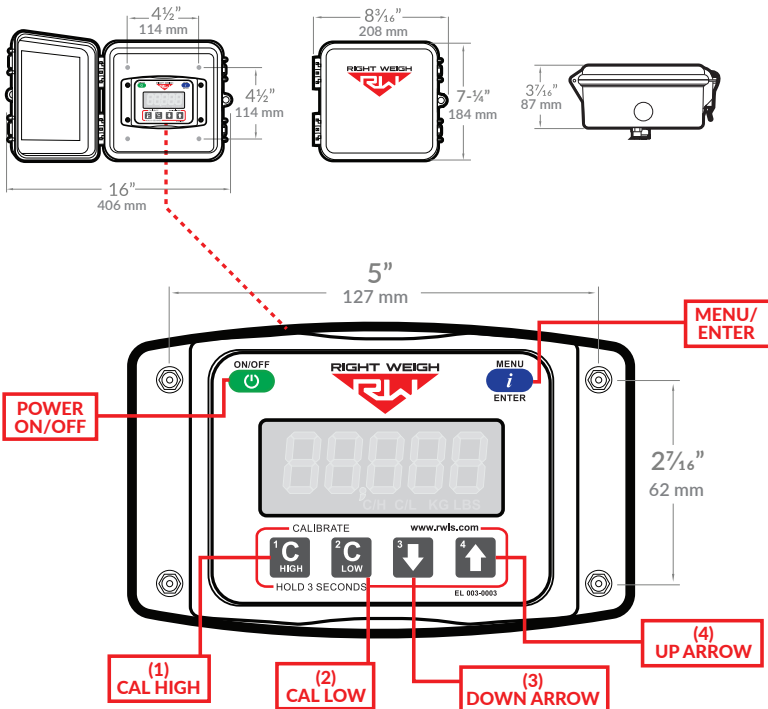

1 CHOOSE LOCATION

The 201-EBT-04 scale is designed to be mounted on the outside of a truck or trailer, however it must still be mounted in a protective enclosure. A protective box and mounting bracket are included with the 201-EBT-04B.

Be sure to choose a location that is easily accessible and safe from potential damage (forklift posts, tire caps, etc.)



DO NOT mount the scale directly to the chassis or any other main beam unless it is approved by the vehicle manufacturer. Doing so may void the warranty with the vehicle manufacturer.

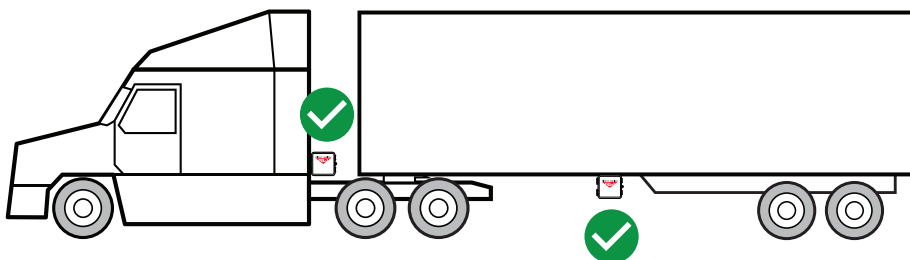

Mount the bracket in the chosen location and install the gauge box to the bracket using supplied hardware.

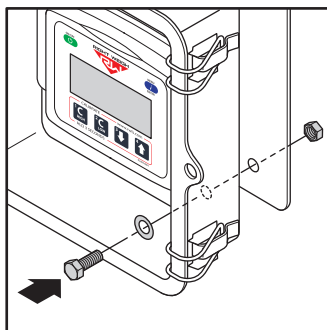

Make sure to use **BOTH** supplied mounting bolts to secure the bracket to the vehicle. Using only one bolt can result in a cracked bracket and the scale falling off the vehicle.

2 DUMP AIR FROM SUSPENSION SYSTEM

3 INSTALL NEW STREET TEE FITTING

Remove the suspension air line fitting from the top of one of the air bags.



Insert a street tee fitting into the top of the air bag that matches the thread size of the vehicle suspension. Reinstall the suspension air line and fitting into the street tee. For more information on the parts needed for air line installation, see Appendix A.

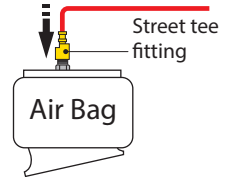

4 INSTALL NEW 1/4" AIR LINE

Install a new 1/4" air line and fitting into the remaining port on the tee.



5 ROUTE AIR LINE TO GAUGE

Route the new 1/4" air line from the tee fitting assembly to the gauge. Secure air line with zip ties. Insert the air line into the push-to-connect fitting on the back of the gauge. **DO NOT ROTATE THE AIR FITTING!**



The air fittings on the back of the gauge are directly connected to the internal circuit board. Applying ground(-) or positive(+9-32) voltage to air fittings will cause immediate air sensor failure!

6 REPEAT STEPS 3-6 WITH SECOND, THIRD, & FOURTH HCV

Each air line should go to an air bag connected to each height control valve. If you are measuring a drive axle group with four separate height control valves, see the image to the right. If you are measuring 4 separate axle groups, make sure one air line is connected to each axle group being monitored.

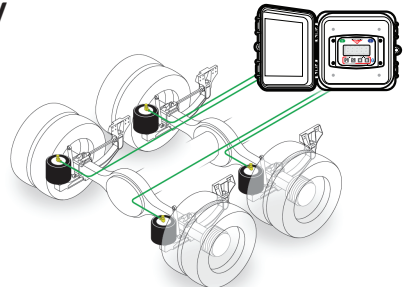

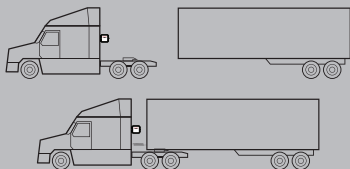

If using the **Remote Sensor Feature**, stop these instructions at this time and follow the instructions on the 403-SK installation manual to finish product installation.

7 INSTALL POWER CABLE

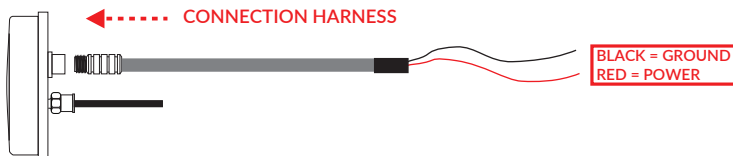

Insert the male connector on the harness onto the female connector on the back of the scale. Make sure to orient the connector properly so that the small cutout on both connectors line up. Once the connector has been pressed in, thread the collar into the scale until it is hand tight.

The two unterminated wires coming out of the harness are used to power the scale. Connect the **RED** wire to a switched positive (+) power source and the **BLACK** wire to chassis ground (-). The required supply voltage must be between 9 and 32 volts DC. For more information on wiring connection and insulation, see Appendix B.



DO NOT connect directly to a battery or any constant power source, gauge should be connected to a switched source so that it can be disconnected from power when not in use. Most users connect the power to vehicle marker lights or the AUX/ABS wire.

Electrical connections **MUST** be insulated, see Appendix B for instructions.

OPERATING MODES



Each vehicle configuration requires a specific operating mode. The modes available on this gauge are:

AVG - Tractor or Trailer, One Axle Group (4 HCV)

S-AVG - Tractor Drive's (4 HCV) and Estimated Steer

F2b2 - Tractor, Straight Truck, Bus, or Fertilizer Spreader Steer (2 HCV) and Drive (2 HCV) Axle Groups

See the tables on the following pages to find your vehicle configuration and set the gauge to the corresponding operating mode.



The load scale can only be setup in one operating mode at a time. If the mode is changed, the calibration data will be reset to factory defaults, requiring re-calibration.

If using the **Remote Sensor Feature**, the feature must be enabled before setting the operating mode. For details on enabling the Remote Sensor feature and setting the operating mode when using this feature, see the 403-SK Instruction Manual (PP-003-0084).

CHANGING OPERATING MODES

1

With the scale OFF, press and hold both the UP and DOWN arrow buttons, and then press the ON/OFF button. Release all 3 buttons. The scale will display the current mode.

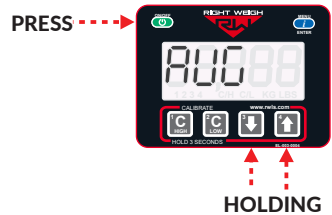

2

Press the UP arrow button to cycle through the operating modes. To confirm your selection, turn the scale off by pressing the ON/OFF button.





The numbers on the images indicate the axle groups that will be displayed on the gauge. To cycle through the axle group on the gauge, press the MENU button.

TRACTOR

VEHICLE CONFIGURATION	OPERATING MODE
<p>Axle Group 1 - Estimated Steer</p> <p>Axle Group 2 - Air Suspension Single, Tandem, or Tri Axle Group (4 HCV)</p> <p>*Recalibration required for steer axle after sliding fifth wheel. For more information about the estimated steer feature, see appendix C.</p>	
<p>Axle Group 1 - Air Suspension Single, Tandem, or Tri Axle Group (4 HCV)</p>	
<p>Steer Axle Group - Air Suspension Single or Tandem Axle Group (2 HCV)</p> <p>Drive Axle Group - Air Suspension Single, Tandem, or Tri Axle Group (2 HCV)</p> <p>*Also available for Straight Trucks, Buses, and Fertilizer Spreaders with the same steer and drive configuration.</p>	

CHANGING UNITS

With the gauge on, press and hold the UP ARROW and then press the MENU button. This will toggle the settings between pounds and kilograms.



+



CALIBRATION

The 201-EBT-04(B) load scale must be calibrated both empty and loaded to work properly. The scale associates the weight you enter with the air pressure in the suspension system at the time of calibration. You will need to calibrate once while the vehicle is empty, and again while the vehicle is loaded for each axle group being monitored.



Only enter on-the-ground weight of axle or group being monitored. **DO NOT** use gross weight, tare weight, etc.

EMPTY CALIBRATION POINT

1: While the vehicle is empty, obtain axle group weights from a certified in-ground scale.

2: Park on a level surface. Shift the transmission to neutral and set the parking brakes. Chock the wheels to prevent unexpected vehicle movement, then release the parking and service brakes.

3: Make sure the Height Control Valve (HCV) has fully inflated the air bags. If needed, briefly dump the air from the suspension and allow the HCV to refill the system.



4: Press the ON/OFF button to turn on the Right Weigh load scale.



5: Press the blue MENU button to select the proper axle group or calibration set.



6: Press and hold the C LOW button until the "C/L" symbol appears.



7: Adjust the value using the UP and DOWN arrows so that it matches your scale ticket for the axle group.



8: To save, press and hold the C LOW button until the "C/L" symbol disappears.

9: Repeat steps 5-8 for all axle groups or calibration sets.

LOADED CALIBRATION POINT



Repeat "empty calibration point" steps 1-3 with the vehicle fully loaded.



4: Press the ON/OFF button to turn on the Right Weigh load scale.



5: Press the blue MENU button to select the proper axle group or calibration set.



6: Press and hold the C HIGH button until the "C/H" symbol appears.



7: Adjust the value using the UP and DOWN arrows so that it matches your scale ticket for the axle group.



8: To save, press and hold the C HIGH button until the "C/H" symbol disappears.

9: Repeat steps 5-8 for all axle groups or calibration sets.

RE-CALIBRATION

It is recommended to re-calibrate every 6 months for each axle group being measured.

SECURITY PIN CODE (OPTIONAL)



It is optional to set a security PIN code on the scale. Once the PIN code has been set, the 5 digit number will be required for calibration at any time.

Once the PIN code is set, it cannot be removed. If you set the PIN code and would like it removed, please call Right Weigh Technical Support listed on page 2.

SET PIN CODE

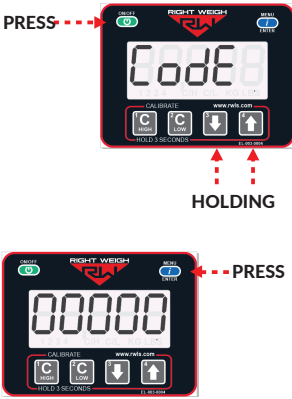

With the gauge off, press and hold both the C LOW and C HIGH buttons, then press the ON/OFF button. Release all three buttons. The gauge will display "Code".

Press the MENU button and "00000" will display on the screen. Enter a 5 digit PIN code using the 1, 2, 3, and 4 buttons. Press the MENU button again to save the code.

**If the display shows "-----", then there is already a code set.

CHANGE PIN CODE

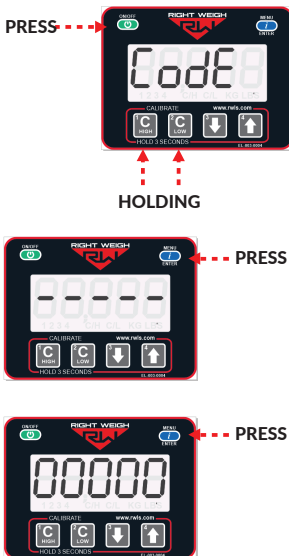

With the gauge off, press and hold both the C LOW and C HIGH buttons, then press the ON/OFF button. Release all three buttons. The gauge will display "Code".

Press the MENU button and "-----" will display on the screen. Enter the previous PIN code. If the code entered is correct, the display will show "Good".

Press the MENU button and enter the new 5-digit PIN code using the 1, 2, 3, and 4 buttons. Press the MENU button again to save the code.

Follow these steps while weighing your vehicle:

1: Park on a level surface. Shift the transmission to neutral and set the parking brakes.

2: Chock the wheels to prevent unexpected vehicle movement, then release the parking and service brakes.

3: Make sure the Height Control Valve (HCV) has fully inflated the air bags. If needed, briefly dump the air from the suspension and allow the HCV to refill the system. (This may take several minutes depending on the type of HCV.)



4: Press the ON/OFF button to turn on the Right Weigh load scale.

5: Adjust the suspension or the load itself until the Right Weigh load scale displays a weight value below your legal limit.



6: Press the blue MENU button to display other axle groups or calibration sets.



7: Press the ON/OFF button to turn off the Right Weigh load scale.

PROBLEM	CAUSE	SOLUTION
Erratic / Inaccurate Weight Readings	The vehicle is not parked on a level surface	Park on level concrete ground. Parking on sloped or banked surfaces will cause the vehicle weight distribution to shift between the axle groups. Additionally, if one or more of the vehicle's wheels are in a pothole, that could result in additional pressure or torque on the suspension air bags. This will cause the suspension to have a different air pressure than what is normally needed to hold up the given weight.
	The vehicle's brakes are on	Release the parking brakes when weighing and/or calibrating. When the vehicle brakes are set, they could apply additional pressure or torque on the suspension air bags. This will cause the suspension to have a different air pressure than what is normally needed to hold up the given weight.
	There is a significant air leak in the suspension system	Check air lines for leaks. Having a leak could cause the HCV to refill the suspension at regular intervals to maintain the vehicle's ride height. If there is a significant leak, the gauge display will slowly decrease in value and then quickly increase in value when the HCV refills the suspension system.
	The Height Control Valve (HCV) is malfunctioning or broken	If the HCV is not functioning correctly, the air pressure applied to the suspension system could be inconsistent and/or erratic. To test for an HCV problem, acquire a weight reading from the Right Weigh gauge and write it down (refer to gauge operating instructions for proper procedure). Drive the vehicle around the block and return to the same location. Acquire a second reading from the Right Weigh gauge. If the two readings are significantly different, then the HCV might be malfunctioning.
Gauge reading "noAir"	One or more air inputs are not receiving air (If 2 air sensors are set to Average mode and one isn't receiving air, gauge will read noAir message)	Check that all air inputs are receiving air. Pull airline out of air fitting(s) on the back of the gauge. Follow the airline along the vehicle to the airbags to check that it hasn't been pinched or damaged. Dump suspension and refill to ensure air bags are full.
	Lift Axle being measured is in the up position	If an air input is measuring a lift axle on the vehicle and the lift axle is in the up position, the air bags will be deflated of air and the gauge will read the noAir message.
App Won't Connect to the Gauge	Scale is connected to a constant power source	Connect the scale to a switched power source between 9 and 32 VDC (typically either the vehicle marker lights or the AUX/ABS wire). If the gauge is powered too long it can stop transmitting a Bluetooth signal and may need to be disconnected and reconnected to work again.
	Scale is connected to another device	Disconnect the scale from the other device before connecting through your device.
	Phone requires re-set	To reset your phone - close the app, turn off Bluetooth, and wait 10 seconds. Then open the app and turn the Bluetooth back on. Try rescanning for the scale. If this still doesn't work, in some cases it is necessary to restart the phone completely.
Gauge Will Not Calibrate Low/High	Air pressure in the system is not changing	To enter low or high cal mode, the gauge must see a measurable change in air pressure. Make sure you calibrate high when the vehicle is near the legal limit and calibrate low when the truck is empty. Also, be sure the air line is connected directly to an air bag - NOT the main air supply or brake system.

PROBLEM	CAUSE	SOLUTION
Scale Does Not Power On	Scale is not connected to a switched power source of between 9 and 32 VDC	Connect the scale to a switched power source between 9 and 32 VDC (typically either the vehicle marker lights or the AUX/ABS wire). If there is a bad connection in the circuit which causes voltage to drop below 9 volts, the scale will not power on. Test the power source with a voltmeter.
	Scale is connected directly to the battery	Connect the scale to a switched power source between 9 and 32 VDC (typically either the vehicle marker lights or the AUX/ABS wire). The scale is active anytime it is connected to power, even if the display is off. To reset it, disconnect and reconnect to the power source, wait 10 seconds, then try again to turn the display on.
	Polarity is incorrect	Correct the polarity. The red wire must be connected to positive and the black to negative.
Cannot Change Calibration Data	The scale has an active user-defined security PIN code	If the scale is protected with a PIN code, the PIN must be entered before calibration data can be changed. To understand how to reset the PIN code, see page 16. If the PIN code has been forgotten, please call Right Weigh technical support listed on page 2 for further assistance.

The following is a list of additional parts needed for air line installation. This list is just a suggestion and may not be all of the parts needed for your specific vehicle. These parts are sold separately in the 103-SK kit:

1/4 Inch Air Line

Approximately 6 to 9 meters

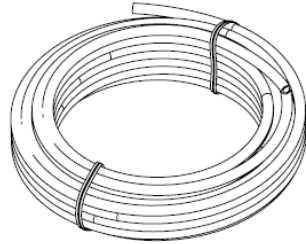

15 or more Zip Ties

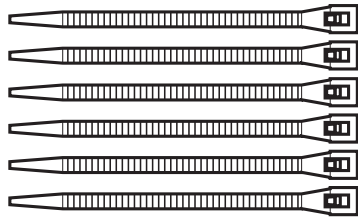

Tube to Female Thread Fitting

Tube fitting for 1/4" air line, with a thread size to match the male branch tee fitting.

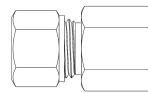

Male Branch Tee Fitting

The tube fitting size should match that of the existing air line that supplies the suspension air bag.

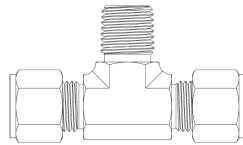

It is important that all wiring connections be made watertight. Connections which are not watertight can develop corrosion and result in loss of contact over time. Heat shrink type butt connectors are recommended.

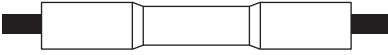

Crimp each end of the wire into the connector with a wire crimp tool (tool not provided).

After crimping and heat shrinking



With a heat gun or heat torch, heat the connector until it shrinks completely around each wire end. Make sure you do not burn the wire jacket.

Add heat shrink



After heat shrinking



After all connections have been made, heat shrink the entire group of splices so that it seals on the outer jacket of both cables.

ESTIMATED STEER

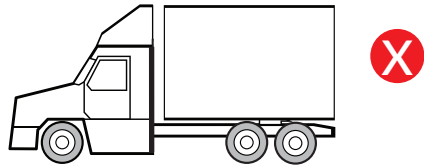
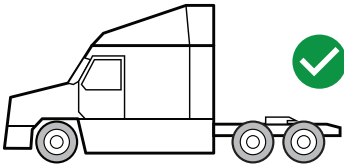

“Estimated Steer” is a calculation of the steer axle weight based on the drive axle’s air pressure. There are no sensors or air bags required on the steer axle to use this feature and it can be more accurate than measuring the weight change with an air or strain sensor. The steer axle weight can be estimated because the weight placed on a fixed position 5th wheel is in a consistent, predictable location on the frame. After calibration, the Right Weigh gauge calculates how many pounds of weight are typically placed on the steer axle, for every pound placed on the drive axle group.

Estimated Steer will not reliably work for straight trucks, car haulers, or anyone who slides their fifth wheel regularly, as the weight applied to the drives is not in a consistent place.

CALIBRATION

Enter the weight data for the steer axle both empty and loaded, exactly the same as you would any other axle group. Based on the data you input and the measurement from the drive axle group, the scale will calculate your steer axle weight.



Re-calibration is required after changing the position of a sliding fifth wheel.



WARRANTY & RETURN POLICY

Right Weigh is committed to providing quality products that function as intended, and we always stand behind our workmanship. Our industry leading warranty is our best effort to express this commitment. Products manufactured or sold by Right Weigh, Inc. are warrantied to be free from significant defects in material and workmanship 3 years from date of purchase. During this time, and within the boundaries set forth in this warranty statement, Right Weigh, Inc. will, at its sole discretion, correct the product problem or replace the product.

This warranty shall not apply to product problems resulting from: (1) Improper application, installation, incorrect wiring, or operation outside of the approved specifications of the product. (2) Accidents, faulty suspension parts or power surges (3) Inadequate maintenance or preparation by the buyer or user (4) Abuse, misuse, or unauthorized modification. (5) Acts of God, lightning strike, floods, fire, earthquake, etc.

Right Weigh, Inc. assumes no responsibility or liability for any loss or damages resulting from use of Right Weigh, Inc. products.

In no event shall Right Weigh, Inc. be liable for direct, indirect, special, incidental or consequential damages (including loss of profits or loss of time) resulting from the performance of a Right Weigh, Inc. product. In all cases, Right Weigh, Inc. liability will be limited to the original cost of the product in question. Right Weigh, Inc. reserves the right to make improvements in design, construction, and appearance of products without notice.

Return Policy and Authorization

Before returning any product, please obtain a Return Merchandise Authorization number (RMA#) by calling Customer Service at 503-628-0838 or e-mailing support@rws.com. Include the RMA# and information regarding the reason for the return with the returned product. Shipping costs for returns must be prepaid by the customer. For your protection, items must be carefully packed to prevent damage in shipment and insured against possible damage or loss. Right Weigh, Inc. will not be responsible for damage resulting from careless or insufficient packing or loss in transit.

An RMA# must be obtained by the original purchaser before any product can be returned. Only new, unused products may be returned. Installed, used, damaged, modified or customized products can not be returned for credit. Credit will be issued to the original purchaser after evaluation by Right Weigh, Inc.

Repairs/Replacements

An RMA# must be obtained before any product can be returned. Right Weigh, Inc. will evaluate returned products at no charge. If Right Weigh, Inc. determines that the returned product is under warranty it will repair the product or parts thereof at no charge, or if unrepairable, replace it with the same or functionally equivalent product whenever possible. Right Weigh, Inc. will return the product at its expense via a shipping method (carrier to be at sole discretion of Right Weigh, Inc.) equal to or faster than the method used by the customer. Products or parts thereof not covered by warranty will be repaired or replaced at customer expense upon authorization by the customer. Right Weigh, Inc. will return the repaired product at customer expense via a shipping method (carrier to be at sole discretion of Right Weigh, Inc.) equal to or faster than the method used by the customer.

THANK YOU FOR YOUR BUSINESS

Thank you for choosing to drive more and scale less! Here at Right Weigh, we are committed to making our products simple to install and easy to use. We understand that installation can vary between vehicles and yours may not be described in this manual. In any event, our technical support team is ready to answer your questions!

SCAN FOR ADDITIONAL RESOURCES



CONTACT US FOR
ADDITIONAL SUPPORT

FOLLOW US!



(503) 628-0838



support@rwls.com



www.rwls.com



RightWeighInc



rightweigh_inc



rwlsinc



right-weigh-inc-