

RIGHT WEIGH



Installation Manual

AIR LINE AND ELECTRICAL INSTALLATION KIT

FOR 201 SERIES | 201-SK

For additional support contact:

United States and Canada:

Right Weigh, Inc.

(888) 818-2058

www.rwls.com

support@rwls.com

Australia and New Zealand:

Smart Truck Solutions

+61 418 622840

rightweigh.com.au

RIGHT WEIGH



Right Weigh, Inc.
Hillsboro, Oregon USA

PP-003-0008 Revision C
December 2019

©2015-2019 Right Weigh, Inc. All rights reserved.

PARTS INCLUDED

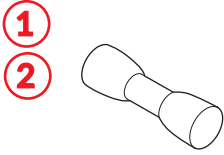

4 Heat Shrink
Wire Connectors

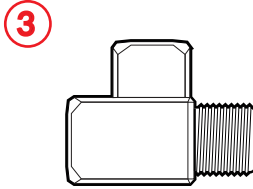

1/4" NPT Street
Tee Fitting

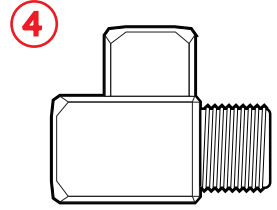

3/8" NPT Street
Tee Fitting

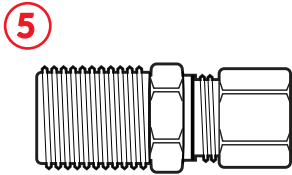

1/4" NPT Male
Straight Fitting

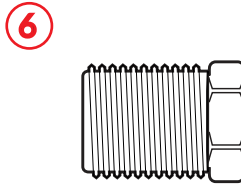

3/8" NPT to 1/4"
NPT Reducer
Fitting

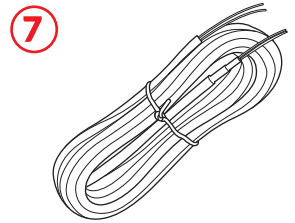

Power and
Ground Extension
Cable

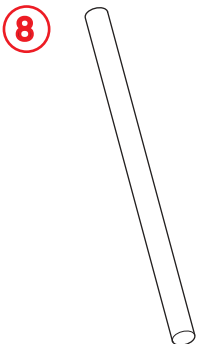

2 Heat Shrink
Tubes

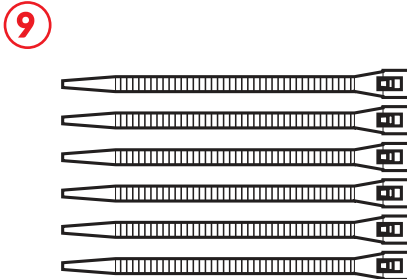

30 Zip Ties

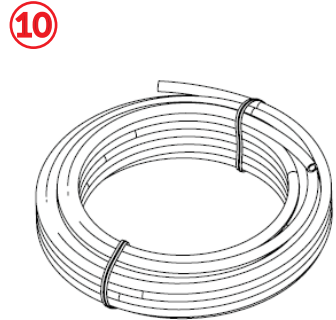

1/4 Inch Air Line

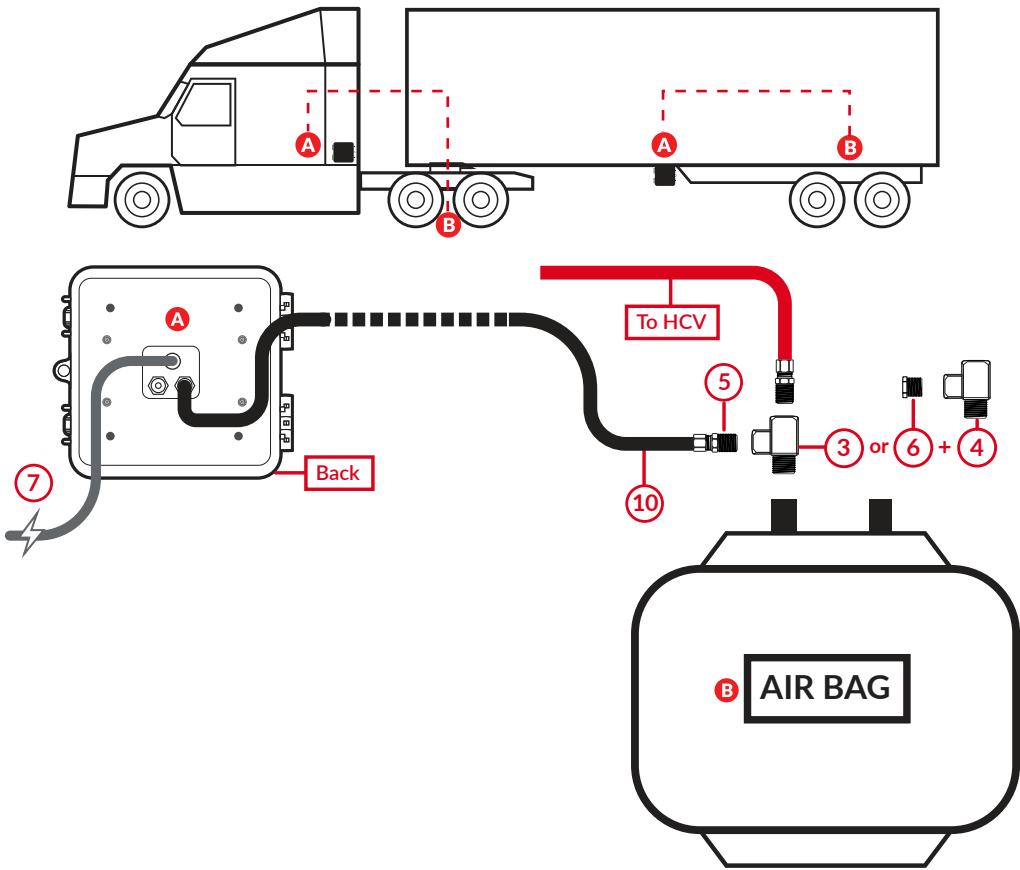

WATER PROOF HEAT SHRINK WIRE CONNECTION

Crimp each end of the wire into the connector with a wire crimp tool (tool not provided).

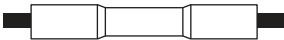

With a heat gun or heat torch, heat the connector until it shrinks completely around each wire end. Make sure you do not burn the wire jacket.



After all connections have been made, heat shrink the entire group of splices so that it seals on the outer jacket of both cables.

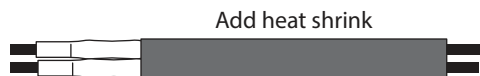

After heat shrinking



Thank you for choosing to drive more and scale less! Here at Right Weigh, we are committed to making our products simple to install and easy to use. We understand that installation can vary between vehicles and yours may not be described in this manual. In any event, our technical support team is ready to answer your questions!



(503) 628-0838

(888) 818-2058 - Toll Free (USA ONLY)

+61 418 622840 - Australia & New Zealand



support@rwls.com

leigh@rwlsau.com.au - Australia & New Zealand



www.rwls.com/how-to-calibrate-install/

rightweigh.com.au - Australia & New Zealand

IMPORTANT!

Please read instructions **COMPLETELY** and thoroughly before installation. Right Weigh, Inc. is not responsible or liable for product failure or vehicle damage due to improper installation. The installation requirements are outlined in this manual and should be followed thoroughly to avoid inaccuracy or damage to the product.

It is also important to be aware of vehicle manufacturer policies before making modifications to the vehicle. Right Weigh, Inc. is not liable or responsible for issues regarding warranties with other manufacturers. This is the responsibility of the customer. If you are unsure about how these installation practices apply to your vehicle, please contact your vehicle or component manufacturer.

FOLLOW US!

