

# INSTALLATION & OPERATION MANUAL



**ONBOARD LOAD SCALE**  
INTERIOR DIGITAL | 202-DDG-01



Thank you for choosing to drive more and scale less! Here at Right Weigh, we are committed to making our products simple to install and easy to use. If your vehicle configuration is not described in this manual, our technical support team is ready to answer your questions!



(503) 628-0838  
(888) 818-2058 - Toll Free (USA ONLY)  
+61 418 622840 - Australia & New Zealand



support@rwls.com  
leigh@rwlsau.com.au - Australia & New Zealand



[www.rwls.com/how-to-calibrate-install/](http://www.rwls.com/how-to-calibrate-install/)  
[rightweigh.com.au](http://rightweigh.com.au) - Australia & New Zealand

## IMPORTANT!

Please read instructions COMPLETELY and thoroughly before installation. Right Weigh, Inc. is not responsible or liable for product failure or vehicle damage due to improper installation. The installation requirements are outlined in this manual and should be followed thoroughly to avoid inaccuracy or damage to the product.

It is also important to be aware of vehicle manufacturer policies before making modifications to the vehicle. Right Weigh, Inc. is not liable or responsible for issues regarding warranties with other manufacturers. This is the responsibility of the customer. If you are unsure about how these installation practices apply to your vehicle, please contact your vehicle or component manufacturer.

Product Overview	4
Installation	6
Setup	10
Calibration	13
Operate & Weigh	16
Security PIN Code	17
Reset Calibration Data	18
Reset To Factory Default	19
Troubleshooting	20
Appendix A - Additional Parts	22
Warranty Statement, Return Policy, & Repairs	23

# PRODUCT OVERVIEW



The Right Weigh 202-DDG-01 digital load scale has one internal air pressure sensor. This scale will monitor one air suspension single, tandem, or tridem axle group with one Height Control Valve (HCV).

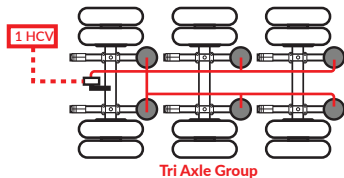
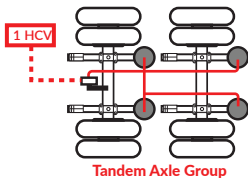
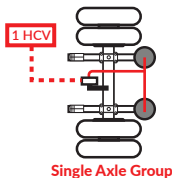

The 202-DDG-01 cannot be used on an axle group that has two HCVs or to monitor more than one axle group. To do this you will need either the 202-DDG-02, 202-DDG-03, or 202-DDG-04 depending on specific vehicle configuration and the amount of axle groups to be monitored.

## Estimated Steer Axle:

The weight of the steer axle can be estimated if this scale is used to monitor the drive axle group. Refer to the Estimated Steer Mode section for more information.

## Technical Specifications:

Operating Temperature: -4° F to +185° F (-20° C to +85° C)

Storage Temperature: -4° F to +185° F (-20° C to +85° C)

Power Requirement: 9 VDC to 32 VDC (Switched)

Units: Pounds (LBS) or Kilograms (KG)

Housing: ABS/PC Blend

Display: Capacitave Touch

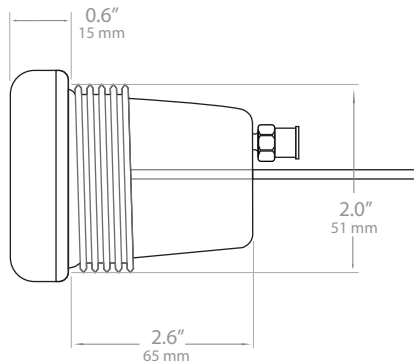
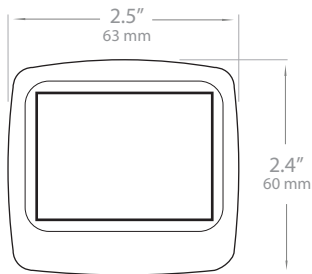

The 202-DDG-01 scale is designed to be mounted inside the vehicle cabin, it is not for outdoor use. The following steps will walk you through how to correctly mount and install the gauge.

## 1 CHOOSE MOUNTING LOCATION

The gauge can be mounted in the dash panel either using an existing factory gauge hole or by creating one. If this option is unavailable or not desirable, Right Weigh has an optional bracket (202-BR) that can be purchased separately to mount the gauge. See below for a detailed list of options for mounting into the dash:

- a** Use an available 2 1/16" (52mm) factory gauge hole.
- b** Remove and replace a factory installed drive axle air suspension pressure gauge.
- c** Cut a new hole in the dash panel using a 2 1/16" (52mm) hole saw as shown.



Make sure to check behind the dash panel for internal wires and components that may need to be moved to avoid damage.

- d** Use Right Weigh 202-BR bracket or an aftermarket bracket to mount the gauge.

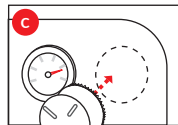
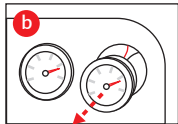
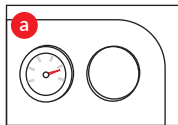

## 2 INSTALL 202 GAUGE

Insert the gauge into the mounting hole or bracket. Hold the gauge in a position so the display appears level on the dash panel or bracket. Note that the thickest portion of the gauge bezel indicates the bottom of the display. Screw the gauge nut onto the back of the gauge until it is tight.

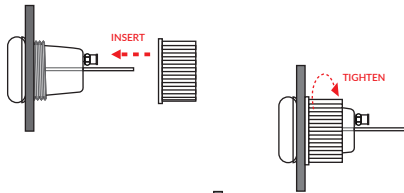

## 3 INSTALL BEZEL STYLING COVER (OPTIONAL)

If desired, place chrome styling cover over the front of the gauge bezel. Press until both sides snap into place.

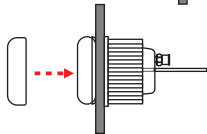

## 4 CONNECT TO POWER AND GROUND

Connect the wiring harness to power and ground. Be sure the RED wire is connected to a SWITCHED positive (+) power source (DO NOT CONNECT DIRECTLY TO BATTERY) and the BLACK wire to chassis ground (-). Supply voltage must be between 9 and 32 volts DC.



DO NOT connect directly to a battery or any constant power source, gauge should be connected to a switched source so that it can be disconnected from power when not in use. Most users connect the power to the ignition switch.

## 5 DUMP AIR FROM SUSPENSION SYSTEM

Connect the wire harness to the connector on the back of the gauge.

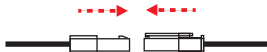

## 6 DUMP AIR FROM SUSPENSION SYSTEM

## 7 INSTALL NEW STREET TEE FITTING

Remove the suspension air line fitting from the top of one of the air bags.

Insert a street tee fitting into the top of the air bag that matches the thread size of the vehicle suspension. Reinstall the suspension air line and fitting into the street tee. For more information on the parts needed for air line installation, see Appendix A.

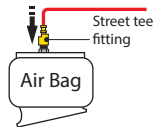

## 8 INSTALL NEW 1/4" AIR LINE

Install a new 1/4" air line and fitting into the remaining port on the tee.





**9 ROUTE AIR LINE TO GAUGE**

Route the new 1/4" air line from the tee fitting assembly to the gauge. Secure air line with zip ties. Insert the air line into the push-to-connect fitting on the back of the gauge.

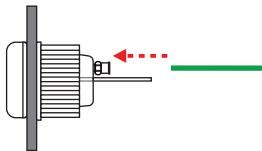
**10 AIR UP SUSPENSION TO CHECK FOR LEAKS****11 RE-ASSEMBLE DASH PANEL IF NEEDED**

# SETUP - CHANGE AIR SENSOR NAMES



The default settings for the gauge can be changed to make the information specific to your vehicle configuration. To change the default air sensor name, follow these steps:

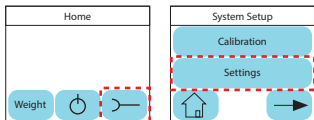

From the Home screen, select the **WRENCH** icon.  
From the System Setup screen, select **SETTINGS**.

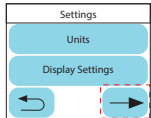
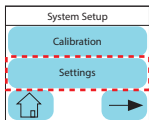

From the Settings screen, select the **RIGHT ARROW** and then select **CONFIG NAMES**.

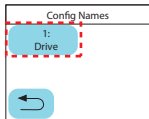
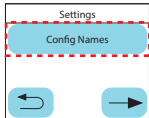

Press the **FIRST SENSOR** to change the name.

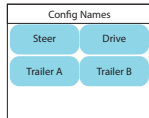

Select the appropriate name from the list. Press the **RIGHT ARROW** for more options.

If the 202-DDG-01 load scale is used to monitor a tractor's drive axle group, the Estimated Steer option can be enabled. Estimated Steer will not work for straight trucks or anyone who slides their fifth wheel regularly. To enable Estimated Steer, follow these steps:

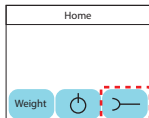

From the Home screen, select the **WRENCH** icon.

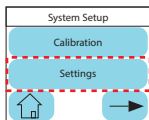

From the System Setup screen, select **SETTINGS**.

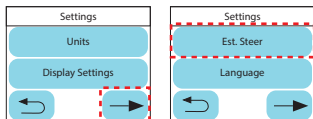

From the Settings screen, select the **RIGHT ARROW** twice and then select **EST. STEER**.

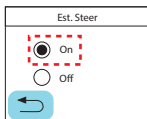

To turn on Estimated Steer, make sure the **“ON”** button is selected as shown.

# SETUP - UNITS / BACKLIGHT

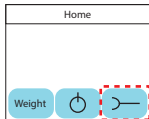

From the Home screen, select the **WRENCH** icon.

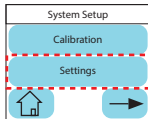

From the System Setup screen, select **SETTINGS**.

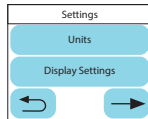

From the Settings screen select either **UNITS** or **DISPLAY SETTINGS**.

## CHANGING UNITS

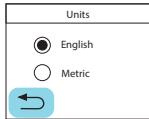

The gauge can be set to read in **ENGLISH (LBS)** or **METRIC (KG)**. Make sure the button is selected next to the units settings desired.

## BACKLIGHT

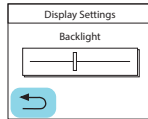

Use the slider to adjust the backlight.

The 202-DDG-01 load scale must be calibrated both empty and loaded to work properly. The scale associates the air pressure in the suspension system to the weight you enter at the time of calibration. You will need to calibrate once while the vehicle is empty, and again while the vehicle is loaded for the axle group being monitored.

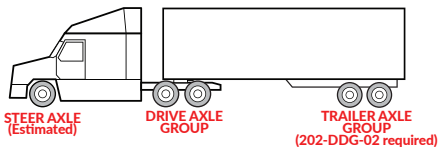

Only enter on-the-ground weight of axle or group being monitored. DO NOT use gross weight, tare weight, etc.

Follow calibration steps on the next page, once these are complete the gauge will be ready to use!

# CALIBRATION - EMPTY



1. While the vehicle is empty, obtain axle group weights from a certified in-ground scale.
2. Park on a level surface. Shift the transmission to neutral and set the parking brakes. Chock the wheels to prevent unexpected vehicle movement, then release the parking and service brakes.
3. Make sure the Height Control Valve (HCV) has fully inflated the air bags. If needed, briefly dump the air from the suspension and allow the HCV to refill the system.

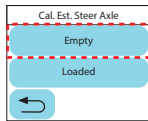
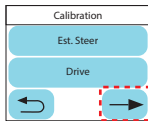
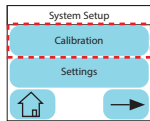
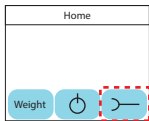

10,800		
1	2	3
4	5	6
7	8	9
Del	0	Enter

4. From the Home screen, select the **WRENCH** icon.
5. From the System Setup screen, select **CALIBRATION**.
6. From the Calibration screen select the appropriate axle group.
7. From the Calibration screen select **EMPTY**. Select **YES** to enter new calibration data.
8. Enter weight from scale ticket for the corresponding axle group and then press **ENTER**. If the value you have entered looks correct, select **YES** to save calibration data.
9. Repeat process for all axle groups being monitored, including steer axle if using Estimated Steer feature.

1. While the vehicle is loaded, obtain axle group weights from a certified in-ground scale.
2. Park on a level surface. Shift the transmission to neutral and set the parking brakes. Chock the wheels to prevent unexpected vehicle movement, then release the parking and service brakes.
3. Make sure the Height Control Valve (HCV) has fully inflated the air bags. If needed, briefly dump the air from the suspension and allow the HCV to refill the system.

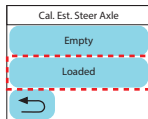
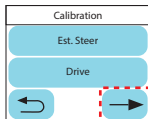
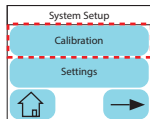
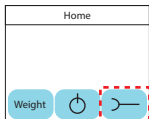

11,460		
1	2	3
4	5	6
7	8	9
Del	0	Enter

4. From the Home screen, select the **WRENCH** icon.
5. From the System Setup screen, select **CALIBRATION**.
6. From the Calibration screen select the appropriate axle group.
7. From the Calibration screen select **LOADED**. Select **YES** to enter new calibration data.
8. Enter weight from scale ticket for the corresponding axle group and then press **ENTER**. If the value you have entered looks correct, select **YES** to save calibration data.
9. Repeat process for all axle groups being monitored, including steer axle if using Estimated Steer feature.

# OPERATE & WEIGH



Follow these steps while weighing your vehicle:

1. Park on level surface. Shift the transmission to neutral and set the parking brakes.
2. Chock the wheels to prevent unexpected vehicle movement, then release the parking and service brakes.
3. Make sure the Height Control Valve (HCV) has fully inflated the air bags. If needed, briefly dump the air from the suspension and allow the HCV to refill the system.

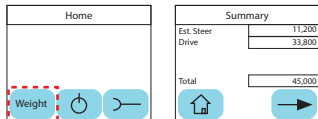

4. From the Home screen, select **WEIGHT**.

5. From the Summary screen, you can view the weight of the axle group being monitored, the estimated steer weight (if this feature is turned on), and the total weight.

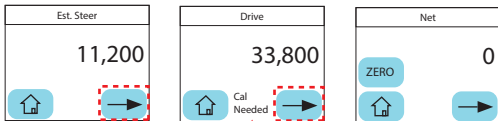

6. From the Summary screen, you can select the **RIGHT ARROW** to view each weight separately and the net weight.

Press the **HOME** button at any time to return to the home screen.

By selecting **ZERO**, the net weight will reset to 0. This reading will display the net change in total weight since the last time the **ZERO** button was pressed.



If the screen says "Cal Needed" then further calibration needs to be performed on one or more axle groups.



To protect calibration data from unwanted changes, you can set a security PIN code. When a PIN is set, the user will be required to enter the PIN in order to get into the calibration screens. Follow these steps to set, change, or remove a PIN code:

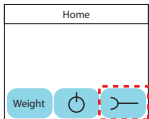

From the Home screen, select the **WRENCH** icon.

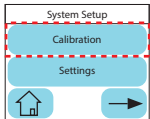

From the System Setup screen, select **CALIBRATION**. Enter current PIN if one already exists.

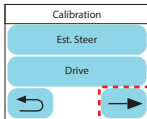

From the Calibration screen select the **RIGHT ARROW** and then select **SET PIN**.

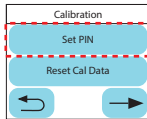

1	2	3
4	5	6
7	8	9
Del	0	Enter

Enter a unique PIN code (up to 6 digits). If you would like to remove a current PIN, remove all characters. Press **ENTER** to save.



If a PIN code is forgotten or lost, please contact Right Weigh technical support listed on page 2 for instructions on how to reset the PIN code.

# RESET CALIBRATION DATA



In rare cases, it might be necessary to reset the calibration data back to the original default values. To reset the calibration data to the default values, follow these steps:

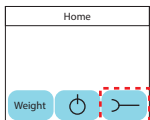

From the Home screen, select the **WRENCH** icon.

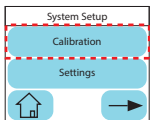

From the System Setup screen, select **CALIBRATION**. You will be prompted to enter your PIN code if one is set.

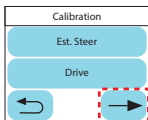

From the Calibration screen select the **RIGHT ARROW** and then select **RESET CAL DATA**.

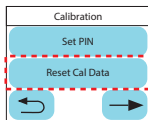

To reset the calibration back to the default values (erase any previous calibration data) select **YES**.

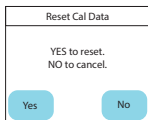

# RESET TO FACTORY DEFAULT

If there is a problem with the gauge, it may be necessary to reset it completely back to factory default settings. This will remove previously set calibration data, air sensor configuration and names, PIN code, etc. To reset the gauge, follow these steps:

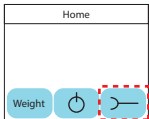

From the Home screen, select the **WRENCH** icon.

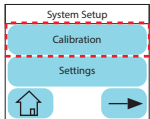

From the System Setup screen, select **CALIBRATION**. You will be prompted to enter your PIN code if one is set.

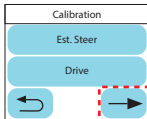

From the Calibration screen select the **RIGHT ARROW** twice and then select **FACTORY DEFAULTS**.

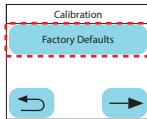

To reset the gauge back to the factory default settings, select **YES**.

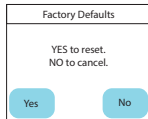

PROBLEM	CAUSE	SOLUTION
Erratic / Inaccurate Weight Readings	The vehicle is not parked on a level surface	Park on level concrete ground. Parking on sloped or banked surfaces will cause the vehicle weight distribution to shift between the axle groups. Additionally, if one or more of the vehicle's wheels are in a pothole, that could result in additional pressure or torque on the suspension air bags. This will cause the suspension to have a different air pressure than what is normally needed to hold up the given weight.
	The vehicle's brakes are on	Release the parking brakes when weighing and/or calibrating. When the vehicle brakes are set, they could apply additional pressure or torque on the suspension air bags. This will cause the suspension to have a different air pressure than what is normally needed to hold up the given weight.
	There is a significant air leak in the suspension system	Check air lines for leaks. Having a leak could cause the HCV to refill the suspension at regular intervals to maintain the vehicle's ride height. If there is a significant leak, the gauge display will slowly decrease in value and then quickly increase in value when the HCV refills the suspension system.
	The Height Control Valve (HCV) is malfunctioning or broken	If the HCV is not functioning correctly, the air pressure applied to the suspension system could be inconsistent and/or erratic. To test for an HCV problem, acquire a weight reading from the Right Weigh gauge and write it down (refer to gauge operating instructions for proper procedure). Drive the vehicle around the block and return to the same location. Acquire a second reading from the Right Weigh gauge. If the two readings are significantly different, then the HCV might be malfunctioning.

PROBLEM	CAUSE	SOLUTION
Scale Does Not Power On	Scale is not connected to a switched power source of between 9 and 32 VDC	Connect the scale to a switched power source between 9 and 32 VDC (typically either the vehicle marker lights or the AUX/ABS wire). If there is a bad connection in the circuit which causes voltage to drop below 9 volts, the scale will not power on. Test the power source with a voltmeter.
	Scale is connected directly to the battery	Connect the scale to a switched power source between 9 and 32 VDC (typically either the vehicle marker lights or the AUX/ABS wire). The scale is active anytime it is connected to power, even if the display is off. To reset it, disconnect and reconnect to the power source, wait 10 seconds, then try again to turn the display on.
	Polarity is incorrect	Correct the polarity. The red wire must be connected to positive and the black to negative.
Cannot Change Calibration Data	The scale has an active user-defined security PIN code	If the scale is protected with a PIN code, the PIN must be entered before calibration data can be changed. To understand how to reset the PIN code, see page 16. If the PIN code has been forgotten, please call Right Weigh technical support listed on page 2 for further assistance.
Gauge Will Not Calibrate Low/High	Air pressure in the system is not changing	To enter low or high cal mode, the gauge must see a measurable change in air pressure. Make sure you calibrate high when the vehicle is near the legal limit and calibrate low when the truck is empty. Also, be sure the air line is connected directly to an air bag - NOT the main air supply or brake system.

The following is a list of additional parts that may be needed for air line installation. This list is just a suggestion and may not be all of the parts needed for your specific vehicle. These parts are included in installation kit 101-SK (sold separately):



## 1/4 Inch Air Line

Approximately 20 to 30 feet  
(6 to 9 meters)

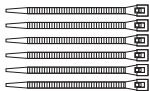

## 20 or more Zip Ties



## Street Tee Fitting

The thread size should  
match the air bag fitting.  
(1/4" NPT or 3/8" NPT)

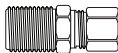

## Male Straight Tube Fitting

Tube fitting for 1/4" air line, with a thread  
size to match the street tee fitting.



# WARRANTY & RETURN POLICY

Right Weigh is committed to providing quality products that function as intended, and we always stand behind our workmanship. Our industry leading warranty is our best effort to express this commitment. Products manufactured or sold by Right Weigh, Inc. are warranted to be free from significant defects in material and workmanship 3 years from date of purchase. During this time, and within the boundaries set forth in this warranty statement, Right Weigh, Inc. will, at its sole discretion, correct the product problem or replace the product.

This warranty shall not apply to product problems resulting from: (1) Improper application, installation, incorrect wiring, or operation outside of the approved specifications of the product. (2) Accidents, faulty suspension parts or power surges (3) Inadequate maintenance or preparation by the buyer or user (4) Abuse, misuse, or unauthorized modification. (5) Acts of God, lightning strike, floods, fire, earthquake, etc.

Right Weigh, Inc. assumes no responsibility or liability for any loss or damages resulting from use of Right Weigh, Inc. products.

In no event shall Right Weigh, Inc. be liable for direct, indirect, special, incidental or consequential damages (including loss of profits or loss of time) resulting from the performance of a Right Weigh, Inc. product. In all cases, Right Weigh, Inc. liability will be limited to the original cost of the product in question. Right Weigh, Inc. reserves the right to make improvements in design, construction, and appearance of products without notice

## Return Policy and Authorization

Before returning any product, please obtain a Return Merchandise Authorization number (RMA#) by calling Customer Service at 503-628-0838 or e-mailing support@rwls.com. Include the RMA# and information regarding the reason for the return with the returned product. Shipping costs for returns must be prepaid by the customer. For your protection, items must be carefully packed to prevent damage in shipment and insured against possible damage or loss. Right Weigh, Inc. will not be responsible for damage resulting from careless or insufficient packing or loss in transit.

An RMA# must be obtained by the original purchaser before any product can be returned. Only new, unused products may be returned. Installed, used, damaged, modified or customized products can not be returned for credit. Credit will be issued to the original purchaser after evaluation by Right Weigh, Inc.

## Repairs/Replacements

An RMA# must be obtained before any product can be returned. Right Weigh, Inc. will evaluate returned products at no charge. If Right Weigh, Inc. determines that the returned product is under warranty it will repair the product or parts thereof at no charge, or if unrepairable, replace it with the same or functionally equivalent product whenever possible. Right Weigh, Inc. will return the product at its expense via a shipping method (carrier to be at sole discretion of Right Weigh, Inc.) equal to or faster than the method used by the customer. Products or parts thereof not covered by warranty will be repaired or replaced at customer expense upon authorization by the customer. Right Weigh, Inc. will return the repaired product at customer expense via a shipping method (carrier to be at sole discretion of Right Weigh, Inc.) equal to or faster than the method used by the customer.

# THANK YOU FOR YOUR BUSINESS

SCAN HERE FOR ADDITIONAL  
RESOURCES AND VIDEOS

RIGHT WEIGH



[www.rwls.com/manuals-resources/](http://www.rwls.com/manuals-resources/)



RightWeighInc



rightweigh\_inc



rwlsinc



right-weigh-inc-

Right Weigh, Inc.  
Hillsboro, Oregon USA

©2015-2022 Right Weigh, Inc. All rights reserved.

PP-003-0002 Revision J  
February 2022