



Installation & Operation Manual



ONBOARD LOAD SCALE

EXTERIOR ANALOG | 250 Series

Thank you for choosing to drive more and scale less! Here at Right Weigh, we are committed to making our products simple to install and easy to use. We understand that installation can vary between vehicles and yours may not be described in this manual. In any event, our technical support team is ready to answer your questions!



(503) 628-0838

(888) 818-2058 - Toll Free (USA ONLY)

+61 418 622840 - Australia & New Zealand



support@rwls.com

leigh@rwlsau.com.au - Australia & New Zealand



www.rwls.com/how-to-calibrate-install/

rightweigh.com.au - Australia & New Zealand

IMPORTANT!

Please read instructions COMPLETELY and thoroughly before installation. Right Weigh, Inc. is not responsible or liable for any negative consequences as a result of improper installation or operation including, but not limited to, product failure or damage that could affect the integrity of the vehicle.

The installation steps in this manual are for the sole use of trained installers. Right Weigh, Inc. accepts no responsibility or liability for issues involving, but not limited to, incorrect installation that occur from misinterpretation of the steps outlined in this document.

It is the end user's responsibility to be aware of vehicle manufacturer policies before making modifications to the vehicle. Right Weigh, Inc. is not liable or responsible for issues regarding, but not limited to, warranties with other manufacturers. This is the responsibility of the end user.

For a more detailed explanation of the the warranty and liability of Right Weigh, Inc. please refer to the "Warranty Statement" and "Return Policy & Repairs" section of this document and www.rwls.com/warranty.

FOLLOW US!



Parts Required	4
Specifications & Overview	5
Scale Installation	6
Calibration and Operation	8
Troubleshooting	9
Appendix A	10
Warranty Statement & Return Policy	11

PARTS REQUIRED



PARTS INCLUDED:

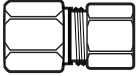

1/4" NPT Female Compression Fitting to 1/4" Air Line

For product numbers ending in "6", a 6mm compression sleeve is provided instead

FLANGE MOUNT GAUGE OR LOWER MOUNT GAUGE

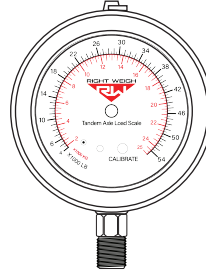
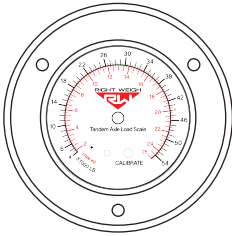

ADDITIONAL PARTS REQUIRED:

Parts sold separately in Air Line Installation Kit (Part Number 101-SK):

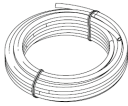

Polyethylene Air Line (30 feet)

The length of air line needed depends on the mounting location of the gauge. 1/4" air line included in kit, 6mm air line is needed for gauge part numbers ending in "6".

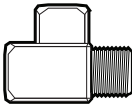

Street Tee Fitting

The thread size and type must match the thread size and type of the vehicle suspension.

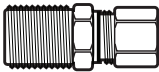

Compression Fitting - Male NPT

The thread size and type must match the thread size and type of the street tee fitting. Compression sleeve must match the diameter of the air line.

FLANGE MOUNT (FF)

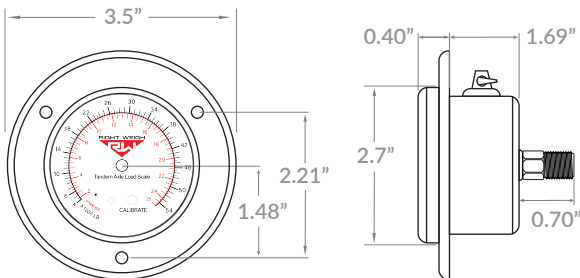

LOWER MOUNT (LM)

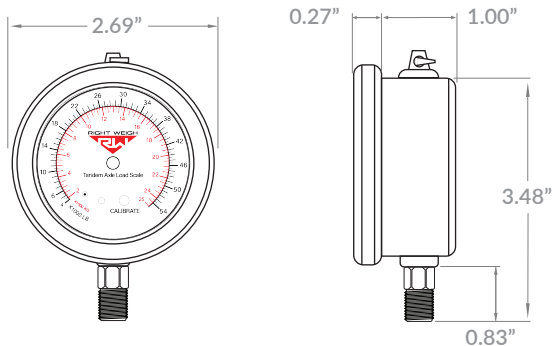

The 250 series is designed for use on an axle group with a single height control valve suspension system. Within this series, there are different products designed for different axle group configurations and each gauge displays both the axle group weight in pounds (lbs) and kilograms (kg). Before installation, make sure you have the proper gauge for your application:

Suspension	Gauge - LBS/KGS
Single Axle	250-30-LM 250-30-FF
Tandem Axle	250-54-LM 250-54-FF
*Hendrickson Tandem Axle	250-HKANT40K-LM 250-HKANT40K-FF
Tri Axle	250-64-LM 250-64-FF

*For use with Hendrickson VANTRAAX HKANT 40K or ULTRAA-K UTKNT 40K air suspension only

If you have the wrong gauge for your application, please call our technical support listed on page 2.

SCALE INSTALLATION



The 250 series gauge is designed to be mounted on the exterior of the truck or trailer. The following steps will walk you through how to correctly mount and install the gauge.



DO NOT mount the scale directly to the chassis or any other main beam unless it is approved by the vehicle manufacturer. Doing so may void the warranty with the vehicle manufacturer.

1 CHOOSE GAUGE LOCATION

Choose a location to mount the gauge that is easily accessible and safe from potential damage (forklift posts, tire caps, etc.). DO NOT mount the gauge yet.

FRONT FLANGE:

Cut a mounting hole of diameter 2 5/8", or replace an existing flange mounted PSI gauge.



DO NOT drill or cut mounting holes in the main chassis or any other part of the vehicle's main framework unless it is approved by the manufacturer. Drilling holes without approval may void your warranty with the vehicle manufacturer.

NOTE:

We offer a mounting bracket (Part Number: 250-BR) that accommodates both the flange mount and the lower mount gauges. Please contact us for more information.

2 MOUNT GAUGE

The gauge must be mounted vertically. DO NOT mount at an angle or sideways. Always install (or remove) the gauge using a wrench on the hex fitting. DO NOT attempt to tighten (or loosen) by turning the housing or any other part of the gauge.

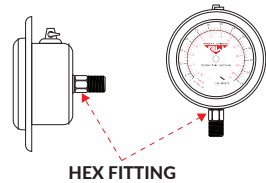

HEX FITTING

3 DUMP AIR FROM SUSPENSION SYSTEM

4 INSTALL NEW STREET TEE FITTING

Remove the suspension air line fitting from the top of one of the air bags.

Insert a street tee fitting into the top of the air bag that matches the thread size of the vehicle suspension. Reinstall the suspension air line and fitting into the street tee.

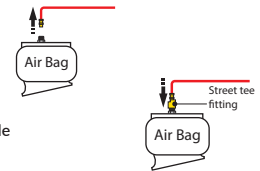

5 INSTALL NEW AIR LINE

Install a new air line and fitting into the remaining port on the tee.



6 ROUTE AIR LINE TO GAUGE

Route the new air line from the tee fitting assembly to the gauge. Secure air line with zip ties. Insert the air line into the fitting on the back of the gauge.

7 INSTALL COMPRESSION FITTING

Install the female compression fitting (included with your gauge). Insert the new air line and tighten.

8 AIR UP SUSPENSION SYSTEM TO CHECK FOR LEAKS

9 PLACE CALIBRATION / OPERATING INSTRUCTIONS STICKER

Place Calibration / Operation Instructions sticker provided on the vehicle in a location that is close to the gauge.

CALIBRATION

- 1: The vehicle must be fully loaded. For best results, calibrate with a loaded weight within 1500lbs or 750kgs of your typical axle group weight (DO NOT calibrate empty!)
- 2: Using a certified in-ground scale, obtain a loaded weight for the axle group attached to the gauge.
- 3: Park on a level surface. Shift the transmission to neutral and set the parking brakes.
- 4: Chock the wheels to prevent unexpected vehicle movement.
- 5: Release the parking brakes.
- 6: For best results, briefly dump the air from the suspension and allow the HCV to refill the system. Make sure the Height Control Valve (HCV) has fully inflated the air bags before proceeding.
- 7: Open the vent on the top of the gauge by switching the yellow tab to "open". For more information on venting the gauge, please see Appendix A.
- 8: Using a flathead screwdriver, turn the calibration screw on the dial face until the gauge matches the certified axle group weight.
- 9: Move the vent tab to the "closed" position.

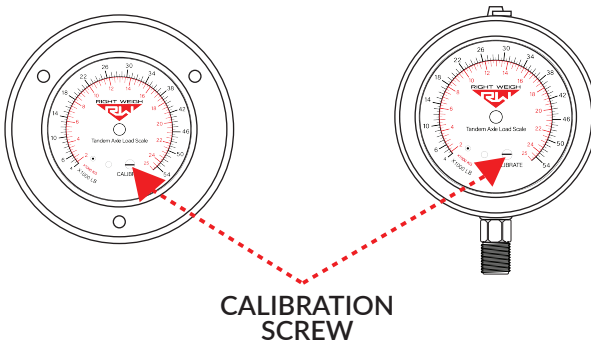
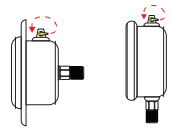

OPERATION / WEIGHING

- 1: Park on a level surface. Shift the transmission to neutral and set the parking brakes.
- 2: Chock the wheels to prevent unexpected vehicle movement. Release the parking brakes.
- 3: Make sure the Height Control Valve (HCV) has fully inflated the air bags. If needed, briefly dump the air from the suspension and allow the HCV to refill the system.
- 4: Open the vent on the top of the gauge by switching the yellow tab to "open".
- 5: View the load scale to determine the on-the-ground axle group weight.
- 6: Move the vent tab to the "closed" position.

PROBLEM	CAUSE	SOLUTION
Erratic / Inaccurate Weight Readings	The vehicle is not parked on a level surface	Park on level concrete ground. Parking on sloped or banked surfaces will cause the vehicle weight distribution to shift between the axle groups. Additionally, if one or more of the vehicle's wheels are in a pothole, that could result in additional pressure or torque on the suspension air bags. This will cause the suspension to have a different air pressure than what is normally needed to hold up the given weight.
	The vehicle's brakes are on	Release the parking brakes when weighing and/or calibrating. When the vehicle brakes are set, they could apply additional pressure or torque on the suspension air bags. This will cause the suspension to have a different air pressure than what is normally needed to hold up the given weight.
	There is a significant air leak in the suspension system	Check air lines for leaks. Having a leak could cause the HCV to refill the suspension at regular intervals to maintain the vehicle's ride height. If there is a significant leak, the gauge display will slowly decrease in value and then quickly increase in value when the HCV refills the suspension system.
	The Height Control Valve (HCV) is malfunctioning or broken	If the HCV is not functioning correctly, the air pressure applied to the suspension system could be inconsistent and/or erratic. To test for an HCV problem, acquire a weight reading from the Right Weigh gauge and write it down (refer to gauge operating instructions for proper procedure). Drive the vehicle around the block and return to the same location. Acquire a second reading from the Right Weigh gauge. If the two readings are significantly different, then the HCV might be malfunctioning.

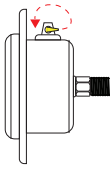

The vent should be moved to the “*open*” position while the gauge is in use.

When the vent is in the closed position, the inside of the gauge is completely sealed and can be affected by external pressure changes. To ensure accurate weight readings, move the vent pin to the “*open*” position when reading.

The vent should be moved to the “*closed*” position while the gauge is **NOT** in use.

When the vent is closed, it prevents any particles and debris from getting inside the gauge. Leaving the vent open can damage the gauge.



WARRANTY & RETURN POLICY

Warranty Statement

Right Weigh is committed to providing quality products that function as intended, and we always stand behind our workmanship. Our industry leading warranty is our best effort to express this commitment. Products manufactured or sold by Right Weigh, Inc. are warranted to be free from significant defects in material and workmanship 3 years from date of purchase. During this time, and within the boundaries set forth in this warranty statement, Right Weigh, Inc. will, at its sole discretion, correct the product problem or replace the product.

This warranty shall not apply to product problems resulting from: (1) Improper application, installation, incorrect wiring, or operation outside of the approved specifications of the product. (2) Accidents, faulty suspension parts or power surges (3) Inadequate maintenance or preparation by the buyer or user (4) Abuse, misuse, or unauthorized modification. (5) Acts of God, lightning strike, floods, fire, earthquake, etc.

Right Weigh, Inc. assumes no responsibility or liability for any loss or damages resulting from use of Right Weigh, Inc. products.

In no event shall Right Weigh, Inc. be liable for direct, indirect, special, incidental or consequential damages (including loss of profits or loss of time) resulting from the performance of a Right Weigh, Inc. product. In all cases, Right Weigh, Inc. liability will be limited to the original cost of the product in question. Right Weigh, Inc. reserves the right to make improvements in design, construction, and appearance of products without notice.

Return Policy and Authorization

Before returning any product, please obtain a Return Merchandise Authorization number (RMA#) by calling Customer Service at +61 418 622840 or e-mailing leigh@rws.com.au. Include the RMA# and information regarding the reason for the return with the returned product. Shipping costs for returns must be prepaid by the customer. For your protection, items must be carefully packed to prevent damage in shipment and insured against possible damage or loss. Right Weigh, Inc. will not be responsible for damage resulting from careless or insufficient packing or loss in transit.

An RMA# must be obtained by the original purchaser before any product can be returned. Only new, unused products may be returned. Installed, used, damaged, modified or customized products can not be returned for credit. Credit will be issued to the original purchaser after evaluation by Right Weigh, Inc.

Repairs/Replacements

An RMA# must be obtained before any product can be returned. Right Weigh, Inc. will evaluate returned products at no charge. If Right Weigh, Inc. determines that the returned product is under warranty it will repair the product or parts thereof at no charge, or if unrepairable, replace it with the same or functionally equivalent product whenever possible. Right Weigh, Inc. will return the product at its expense via a shipping method (carrier to be at sole discretion of Right Weigh, Inc.) equal to or faster than the method used by the customer. Products or parts thereof not covered by warranty will be repaired or replaced at customer expense upon authorization by the customer. Right Weigh, Inc. will return the repaired product at customer expense via a shipping method (carrier to be at sole discretion of Right Weigh, Inc.) equal to or faster than the method used by the customer.

THANK YOU FOR YOUR BUSINESS

Thank you for choosing to drive more and scale less! Here at Right Weigh, we are committed to making our products simple to install and easy to use. We understand that installation can vary between vehicles and yours may not be described in this manual. In any event, our technical support team is ready to answer your questions!

SCAN FOR ADDITIONAL RESOURCES



CONTACT US FOR
ADDITIONAL SUPPORT

FOLLOW US!



(503) 628-0838
(888) 818-2058 - Toll Free (USA ONLY)
Australia - +61 418 622840



support@rwls.com
Australia - leigh@rwls.com.au



www.rwls.com/how-to-calibrate-install/
Australia - rightweigh.com.au



RightWeighInc



rightweigh_inc



rwlsinc



right-weigh-inc-